

ST. PAUL COURSE CALENDAR 2016 – 2017



INTRODUCTION

Dear Students, Parents, Guardians and Members of the St. Paul Community:

Formal education systems are designed to give people the skills and knowledge that they will need to become contributing members in an ever-changing society where dedication, teamwork and lifelong learning are critical. Our Catholic system has those educational goals while also asking that home, school and Church work together to ensure that teaching, learning and playing are all guided in every aspect by the values of Jesus Christ. As a result, along with the curriculum expectations, we teach students at St. Paul Catholic School the importance of blending their spiritual, academic and social lives.

In all courses at St. Paul, the Catholic Graduate Expectations are included in the curriculum planning and those expectations are reflected in our course outlines and daily activities. Whether in Science, Math, Physical Education, English...whatever the subject matter, our staff have the opportunity to speak to our students about their mission here on earth; that we are all stewards of the earth, called to nourish our souls, challenge our minds, expand our God-given talents, honor our bodies, and look beyond ourselves to the needs to each other, the school, community and world.

Within these pages you will be able to review the various educational pathways available to you and you will see that St. Paul offers all the courses and programmes needed to solidly prepare students for their future endeavours. You will also see that we put our Catholic faith tradition into action by offering an environment of mutual respect and a team approach to supporting our students with various needs.

It is a privilege to share with the home, the parish and the wider Christian community, the unique opportunity to nurture the faith of our students while they simultaneously develop the skills, knowledge and values that will enable them to take their place as positive, contributing members of our society.

With pride and respect,

Lisa Gorrell, Principal

Graham Stuart, Vice Principal

Since the opening of St. Paul, our school has been noted for its unique school spirit that supports and fosters a strong sense of community and purpose. This supportive environment allows our students to successfully meet the significant academic and social demands and challenges which are presented to them

ONTARIO CATHOLIC SCHOOL GRADUATE EXPECTATIONS

The Graduate is expected to be:

A discerning believer formed in the Catholic Faith community who celebrates the signs and sacred mystery of God’s presence through word, sacrament, prayer, forgiveness, reflection and moral living.

An effective communicator who speaks, writes and listens honestly and sensitively, responding critically in light of gospel values.

A reflective, creative and holistic thinker who solves problems and makes responsible decisions with an informed moral conscience for the common good.

A self-directed, responsible, lifelong learner who develops and demonstrates their God-given potential.

A collaborative contributor who finds meaning, dignity and vocation in work which respects the rights of all and contributes to the common good.

A caring family member who attends to family, school, parish, and the wider community.

A responsible citizen who gives witness to Catholic social teaching by promoting peace, justice and the sacredness of human life.

ALGONQUIN LAKESHORE CATHOLIC DISTRICT SCHOOL BOARD MISSION

We are a Catholic School System, called to work in partnership with home, parish and community, on our journey to understand and live the way of Jesus Christ.

We are committed to excellence in Catholic education and to lifelong learning, so that those with whom we journey may become caring and contributing citizens in a world of constant challenge.

ST. PAUL CATHOLIC SCHOOL GOALS

Our goal is to provide quality Catholic education in a Christian environment of common understanding and mutual respect. We are dedicated to assist our students:

- to come to know Christ;
- to deepen their commitment to the people of God and their mission to the world
- to develop a positive self image;
- to develop a sense of personal and communal responsibility and discipline;
- to pursue excellence in curricular and extra-curricular activities;
- to develop resourcefulness, creativity, and independent learning habits;
- to acquire knowledge, skills and attitudes that will lead to success in the world of work and further educational responsibilities.

CODE OF CONDUCT

The Code of Conduct is currently under review, however this code will be used as the framework for decision making for the 2016-2017 school year or until the policy is updated.

GUIDING PRINCIPLES

- All participants involved in the Catholic school system – students, parents or guardians, volunteers, teachers and other staff members — are included in this Code of Conduct whether they are on school property, on school buses or at school-authorized events or activities. As members of a Catholic school community, we are called to a way of life which is Christ-like and inspired by the Holy Spirit.
- All members of the school community are sacred and deserving of being treated with respect and dignity.
- Responsible citizenship involves appropriate participation in the civic life of the school community. Active and engaged citizens are aware of their rights, but more importantly, they accept responsibility for protecting their rights and the rights of others.
- Members of the school community are expected to use non-violent means to resolve conflict.
- The possession, use or threatened use of any object to injure another person endangers the safety of oneself and others.
- Alcohol and illegal drugs are addictive and present a health hazard. Ontario schools will work cooperatively with police, drug and alcohol agencies to promote prevention strategies and, where necessary, respond to school members who are in possession of, or under the influence of, alcohol or illegal drugs.
- Members of the school community have a responsibility to maintain an environment where conflict and difference are addressed in a manner characterized by respect and civility.

ROLES AND RESPONSIBILITIES

School Boards provide direction to their schools that ensure opportunity, excellence and accountability in the education system. School boards:

- develop policies that set out how their schools will implement and enforce the Provincial Code of Conduct and all other rules as related to the provincial standards for respect, civility, responsible citizenship and physical safety;
- review these policies regularly with students, staff, school councils, parents or guardians, volunteers and the community;
- communicate the Provincial Code of Conduct to all parents, students and staff to ensure their commitment and support;
- ensure an effective intervention strategy and response to all infractions related to the standards for respect, civility, responsible citizenship and physical safety;
- provide opportunities for all staff to acquire the knowledge, skills and attitudes necessary to develop and maintain academic excellence and safe learning and teaching environments.

Teachers and School staff, under the leadership of their principals:

- help students work to their full potential and develop their self-worth;
- communicate regularly and meaningfully with parents;
- maintain consistent standards of behaviour for all students;
- demonstrate respect for all students, staff and parents;
- prepare students for the full responsibilities of citizenship.

Students are to be treated with respect and dignity. In return, they must demonstrate respect for themselves, for others and for the responsibilities of citizenship through acceptable behaviour. Respect and responsibility are demonstrated when a student:

- comes to school prepared, on time and ready to learn;
- shows respect for themselves, for others and for those in authority;
- refrain from bringing anything to school that may compromise the safety of others;
- follows the established rules and takes responsibility for his or her own action.

Parents play an important role in the education of their children and have a responsibility to support the efforts of school staff in maintaining a safe and respectful learning environment for all students. Parents fulfill this responsibility when they:

- show an active interest in their child's school work and progress;
- communicate regularly with the school;
- help their child be neat, appropriately dressed and prepared for school;
- ensure that their child attends school regularly and on time;
- promptly report to the school their child's absence or late arrival;
- encourage and assist their child in following the rules of behaviour;
- assist school staff in dealing with disciplinary issues.

Police and community members are essential partners in making our schools and communities safer. Community members need to support and respect the rules of their local schools. Police investigate incidents in accordance with the protocol developed with the local school board. These protocols are based on a provincial model developed by the Ministry of the Solicitor General and the Ministry of Education.

STANDARDS OF BEHAVIOUR

Respect, civility and responsible citizenship

All school members must:

- respect and comply with all applicable federal, provincial and municipal laws;
- demonstrate honesty and integrity;
- respect differences in people, their ideas and opinions;
- treat one another with dignity and respect at all times;
- respect and treat others fairly, regardless of their race, ancestry, place of origin, colour, ethnic origin, citizenship, religion, gender, sexual orientation, age or disability;
- respect the rights of others;
- show proper care and regard for school property and the property of others;
- take appropriate measures to help those in need;
- respect persons who are in a position of authority;
- respect the need of others to work in an environment of learning and teaching.

Physical safety

Bullying and harassment of students will not be tolerated. Incidents of this nature should be reported to teachers and administrators immediately. All violent acts, verbal and physical, will be dealt with. Prohibited and non-prohibited weapons, their replicas or any other instruments or objects which could be used to cause bodily harm (eg. water pistols, laser pointers, fireworks) are not permitted on school property. These items (prohibited weapons) will be seized and police or parents will be required to pick them up. Students will be suspended.

St. Paul Administration and teachers work collaboratively with law enforcement agencies in the Quinte West area. Informal and formal visits from these agencies are part of this relationship.

Weapons

All school members must:

- not be in possession of any weapon, including but not limited to firearms;
- not use any object to threaten or intimidate another person;
- not cause injury to any person with an object.

Physical Aggression

All school members must:

- not inflict or encourage others to inflict bodily harm on another person.

Alcohol and Drugs

All school members must:

- not be in possession of, or under the influence of, or provide others with, alcohol or illegal drugs.

Students may be searched if drug or weapons offences are suspected (R. v. MRM, Supreme Court of Canada, 1998).

Non-Smoking Policy

All school members must:

- not smoke or hold lighted tobacco on school property.
- All persons will be fined by the Health Unit's Tobacco Enforcement Officer for smoking or holding lighted tobacco on school property. Absolutely no smoking will be tolerated on school property.

E-cigarettes and vaporizers will be treated in the same way as tobacco

Failure to comply with the St. Paul Code of Conduct will result in progressive disciplinary measures. Grievous actions will be dealt with as outlined in the "Safe Schools Act" (2007) and the "Keeping Our Kids Safe at School Act" (2010), Equity & Inclusive Education in Ontario Schools 2009 PPM 119, Bullying Prevention & Intervention PPM 144, Progressive Discipline & Promoting Positive Student Behaviour PPM 145.

UNIFORM POLICY

Students are expected to wear the school uniform at all times during the school day, and will not be admitted to class otherwise. Halpern's is the official supplier of the school uniform.

Required uniform as issued by Halpern's:

Female

- school kilt, at a length no more than 10 cm. above the knee, or
- grey dress pants, and
- white collared blouse, or
- white, red or navy golf shirt

Male

- grey dress pants, and
- white dress shirt with school tie, or
- white, red or navy golf shirt

Additional Required Uniform Pieces

- footed opaque tights in black, navy or dark grey must be worn with the kilt as part of the regular uniform
- socks in solid white, navy or grey
- black or dark brown dress shoes (no running or skateboard shoes or boots)

Optional

- navy or red cardigan or v-neck sweater with school emblem
- navy sweatshirt or fleece with school emblem
- navy walking shorts (Halpern's only)
- leather sandals worn with socks (no athletic or beach sandals)

*Shorts and sandals may be worn during warm weather as specified by the school administration

Hats are not permitted in the school. On non-uniform days, modest clothing befitting a Catholic school environment will be worn. Students not in full uniform or dressed unsuitably will not be permitted to attend class. Persistent violation of the uniform policy will be interpreted by Administration to mean that the student is unwilling to comply with the policy of the school. They will be counselled to select a school which better meets their needs.

There are important components of the Healthy Active Living program which cannot be met while wearing the regular school uniform. All students are therefore expected to purchase the St. Paul shorts and t-shirts from the Physical Education staff and to wear that alternate uniform with running shoes to Healthy Active Living classes unless otherwise directed by the teacher. Failure to wear the uniform will result in progressive disciplinary measures and could ultimately jeopardize the ability to achieve the credit in this participatory course.

ATTENDANCE POLICY & PROCESS

At St. Paul Catholic Secondary School we take student attendance very seriously; not only is student attendance inextricably linked to the most successful academics, but it is also a matter of safety that we know exactly who we have here at school during the day. Therefore, it is the policy of the school that all students must attend on time, Home Room and all classes, unless they have been legitimately excused by a parent/guardian and the attendance secretary has been advised.

In keeping with that policy, students who are “unaccounted for” by missing classes or Home Room without parental notice to the school, or by failing to sign out will be considered “truant” and will incur the appropriate consequences. Students who are absent or have signed out with parental permission or otherwise, are expected to not be in the building and are ineligible to use any school facilities (library, computer labs, gym etc.) and are also ineligible to participate in any extra-curricular activities for that day. The school attendance monitoring system will call home at the end of the school day to report any absences during the day that fall into this category. The following procedures will assist all of us as we work together with students, parents/guardians and the school staff to minimize concerns.

- As a safety precaution, parents/guardians must notify the school prior to Home-Room when they know that their son/daughter will be absent or late on a given day. The office is open at 7:30 am or a message may be left on the voice-mail at any time.
- When signing in late, or out early, a parental note is required to be in the student agenda and presented to the attendance secretary (and any teacher directly affected by a disruption) upon entering the building or before leaving the building. In cases of unexpected illness, a student may report to the office to make a phone call for parental permission to leave and then bring the note in upon their return to school the next day. Note: the important thing is that the office and parents/guardians are both aware that the student’s attendance is being altered for the day.
- Following an absence, to confirm the phone call has been made to the school for safety reasons, a written note of parental consent is required to be in the student agenda and presented to the attendance secretary before Home Room on the first day of return to school. Upon entry to classes, the note must then be shown to all teachers in order to verify their records.
- It is the student’s responsibility to see teachers about any missed work during an absence. In the case of a missed assignment due-date or test, the student must be prepared to immediately hand in the assignment and/or to write the test that day either during class time or at lunch, as deemed appropriate by the teacher. In cases where teachers are concerned about a pattern of absence for such assessments, the teacher will speak to the student and contact the parent/guardian to inform them that in future, a medical note for absence may be requested for classes missed when assessments have taken place.

Note: During the examination period, medical notes or court-orders are required for legitimizing an absence from an exam.

Students 18 years of age and over may provide their own notes for the above procedures, but the process must still be followed. Although we encourage students to keep their parents/guardians as advocates for them within the system, The Municipal Freedom of Information and Protection of Privacy Act (1989) gives students who have

attained the Age of Majority the right to take control of their own decision-making. This means that the school cannot share with parents/guardians any aspect of the student's activity at school, including attendance, marks, suspensions etc. without the written consent of the student.

VISITORS

All visitors to St. Paul are to go directly to the main office to state their purpose and receive authorization from Administration. The presence of unfamiliar/suspicious persons on school property poses a personal threat to the safety of students and staff. Since the possible motives/responses of such persons are unknown, it is important that students report the location of an intruder to the first staff personnel available and not approach or try to communicate with intruders. Intruders may be issued a "no trespassing" letter which is filed with the school and police. If this warning is violated, a fine will be issued by the police.

Students are not permitted to have student guests on the property. Students from other schools will be asked to leave. Special circumstances may be given consideration, provided a written request is given to Administration 48 hours prior to the visit.

PARKING/TRAFFIC

Parking is not permitted anywhere on the property except in designated areas. Fire routes and bus zones must be kept clear of vehicles at all times. This is to provide safety to the school community so that police, fire or ambulance vehicles can access the property in the event of an emergency. Handicapped parking is available in the front parking lot. Only those vehicles with appropriate stickers are permitted there. Unauthorized parking in these areas will result in fines and/or towing of vehicles at the owner's expense.

Vehicles parked on school property are not to be used as gathering points for students. Students are not permitted to remain in parked vehicles or loiter in the parking areas. All drivers are required to drive with caution while on school property. Failure to comply with these provisions may result in suspension of parking privileges.

LOCKS AND LOCKERS/PERSONAL PROPERTY

Lockers are the property of the school. Students are assigned individual lockers and are not to share their lockers or combinations with another student. Students may use only the Dudley locks sold through the school. Lockers may be searched by administration when necessary. Personal property posted on lockers must be in good taste. Students will be required to remove any material deemed to be inappropriate. Students are discouraged from bringing valuable items and large sums of money to school. St. Paul CSS will not be held responsible for theft of cash or valuable items left in lockers or change rooms.

DIGITAL CITIZENSHIP

Technology continues to expand at an exponential rate. With that growth come implications related to safety, privacy, and intrusion in our school community.

The use of any personal electronic device which interferes with or disrupts academic instruction or learning in the classroom is not permitted. The inappropriate use of such electronic devices will result in progressive disciplinary action. The use of such personal electronic devices in the communication of test or examination contents or in the storage of materials for assessment purposes will result in disciplinary action through the Policy for Academic Integrity as well as carry a disciplinary response of suspension.

The taking, transmission or posting of photographic images of a person or persons, on school property, at school events and during school activities and/or hours, is prohibited without the permission of the person(s) being photographed, the permission of their parent/guardian if they are under the age of 18, and the principal or designate. This is in accordance with Privacy Legislation; therefore, any concern brought forward by a person or persons whose rights have been violated could result in a contact with the Quinte West Detachment of the Ontario Provincial Police.

As a Catholic School, we value our time as a community and therefore want to be both physically and emotionally present to others while here in the building. Having devices such as Ipods or MP3 players on or using cellphones for non-academic reasons impedes our ability to be fully present to one another.

Where a student violates any portion of this policy, the device may be confiscated and kept for the remainder of the day in the school safe before being returned to the student at the end of the student's instructional day. In the case of a repeat violation, the device will be returned to a parent. Progressive disciplinary action, up to and including suspension, will be taken when the violations continue.

DANCE PROTOCOL

- All guests must be signed in during lunch until the Thursday of the week of the dance. There will be one guest per sponsor, and the sponsor from St. Paul is responsible for the behaviour of their guest (exceptions must be approved by administration). A maximum of 75 guests will be permitted. No additional guests after this point may be signed in.
- Everyone, including guests, must present a current Student ID card at the door to gain admittance. Students will not be permitted to verify the identity of guests in the absence of a Student ID.
- Dances will begin at 7:00 p.m. and will end at 11:00 p.m. The doors will remain open until 9:00 p.m. unless the capacity of 500 persons has been reached, in which case no additional participants will be admitted.
- There will be a mandatory coat check at the main entrance for all students and guests. All coats, jackets, bags, etc. must be left at the coat check. All items will be left at the owner's risk. While making every effort to protect checked items, Students' Council accepts no responsibility for personal property damaged, lost or stolen. Students will submit to a search of their personal belongings before entry to the dance.
- Dress code will be as for any non-uniform day. Students failing to comply with dress code will be asked to leave until they find appropriate attire.
- Anyone leaving the dance and going outside will not be allowed re-entry.
- Students' Council and Administration reserve the right to refuse entry or eject any individual whose behaviour is considered inappropriate. This includes anyone found in a restricted area of the school.

- Any individual in the possession of, or under the influence of an illegal substance, will be detained until a parent or guardian arrives, will be subject to a minimum three-day suspension and may face legal charges.

ACADEMIC HONESTY POLICY

Plagiarism is taking another's words, ideas or work (theories, artwork, statistics, music, pictures, graphics, etc.) without acknowledging the source. It is not enough to simply change the language of the original source. You must credit the original source through appropriate documentation.

In Grades 9 and 10 should plagiarism or cheating occur:

- The student and parent/guardian are informed by the subject teacher.
- The student may resubmit the assignment or the teacher may choose to view the assignment as incomplete and permit the demonstration of the curriculum expectations in a different assignment or through an alternate form of assessment.
- Should the student fail to resubmit the assignment, a mark of zero will be assigned.
- The teacher will notify administration by completing an Academic Honesty Report.
- The teacher will remind the student of strategies to avoid plagiarism.

In Grades 11 and 12 should plagiarism or cheating occur:

- The student is informed by the subject teacher and the teacher will contact the parent/guardian, where appropriate.
- The assignment will receive a mark of zero. As determined by the teacher, an alternate assignment or form of assessment may be permitted to demonstrate achievement of the same curriculum expectations.
- The teacher will notify administration by completing an Academic Honesty Report.
- Administration will contact the parent/guardian.

In grades 9 through 12, should subsequent incidents of cheating or plagiarism occur:

- The student is informed by the subject teacher.
- The assignment will receive a mark of zero.
- The teacher will notify administration by completing an Academic Honesty Report.
- The teacher will contact the parent/guardian, where appropriate.
- Administration will meet with the student.
- Administration will inform the parents/guardians by letter.

GENERAL PROGRAM INFORMATION

THE FIFTH YEAR PROGRAM

The Ministry of Education Diploma Requirements make it possible for any student in any pathway to achieve graduation in 4 years. The only viable reason a student can have for returning after 4 years is an academic one. A student who believes they have an academic rationale for return must meet with both their guidance counselor and an administrator as soon as possible to determine if a fifth year is reasonable.

Mark upgrading for courses already taken is not an academically viable reason for a 5th year.

If a fifth year student desires a course change during the year, then that change must be in keeping with the distinct academic plan which was reviewed and agreed to previously by administration.

THE SEMESTER SYSTEM

The school year is divided equally into two semesters:

Semester I: September - January

Semester II: February - June

ASSESSMENT AND EVALUATION OF STUDENT ACHIEVEMENT

The primary purpose of assessment and evaluation is to improve student learning. Information gathered through assessment and evaluation helps teachers identify students' difficulties as well as to detect weaknesses in programs. Assessment and evaluation are thus important tools for adapting curriculum and instructional approaches to students' needs and for determining the overall effectiveness of programs and classroom practises.

Assessment is the process of gathering information from a variety of sources (including assignments, demonstrations, projects, performances, and tests) that accurately reflects how well students are achieving the curriculum expectations. As part of assessment, teachers provide students with descriptive feedback that guides their efforts towards improvement. Evaluation is the process of judging the quality of a student's work on the basis of established achievement criteria, and assigning a value to represent that quality. In Ontario secondary schools, the value assigned will be in the form of a percentage grade.

Assessment and evaluation will be based on the provincial curriculum expectations and the achievement levels outlined in the secondary curriculum policy documents. Seventy percent of the evaluation is based on classroom work and may be determined through a variety of methods such as ongoing class demonstrations, presentations, essays, performances and classroom tests and quizzes. Thirty percent of the evaluation is based on the final summative evaluations that may be determined through a variety of methods such as a portfolio, essay, examination and/or demonstration. The final evaluations reflect the range and level of student skills and knowledge towards the conclusion of the course.

Ontario Curriculum Policy documents and further details regarding the Ministry of Education’s policy on assessment and evaluation for each course can be accessed at www.edu.gov.on.ca. Specific course outlines for each subject are available by contacting each subject teacher.

Percentage Grade Range	Achievement Level	Description
80 – 100%	Level 4	A very high to outstanding level of achievement. Achievement is above the provincial standard.
70 – 79%	Level 3	A high level of achievement. Achievement is at the provincial standard.
60 – 69%	Level 2	A moderate level of achievement. Achievement is below, but approaching the provincial standard.
50 – 59%	Level 1	A passable level of achievement. Achievement is below the provincial standard.
Below 50%		Insufficient achievement of curriculum expectations. A credit will not be granted.
	I	Insufficient evidence of curriculum expectations in Grade 9 or 10 courses. Students may be eligible for credit recovery.

ASSESSMENT & REPORTING

REPORTING AND COMMUNICATION WITH PARENTS

Progress will be reported to students and parents as follows:

Semester I Progress Report	October
Mid-Semester I Report	November
Final Semester I Report	February
Semester II Progress Report	March
Mid-Semester II Report	April
Final Semester II Report	July

Students and parents may at any time request an update of student progress by contacting the student's subject teacher. Scheduled parent-teacher interviews will be arranged following the progress report for each term.

THE PROVINCIAL REPORT CARD

Student achievement is communicated formally to students and parents by means of the Provincial Report Card, Grades 9-12. The report card documents the student's achievement in every course in the form of a percentage grade. It also includes teachers' comments on the students' strengths and weaknesses, specifying the areas in which improvement is needed and the ways in which it might be achieved. The report card contains separate sections for recording attendance and for evaluating the student's learning skills in every course.

THE ONTARIO STUDENT TRANSCRIPT

The Ontario Student Transcript (OST) provides a comprehensive record of a student's overall achievement in high school. The transcript, which is part of the Ontario Student Record (OSR), includes the following information:

- The student's achievement in grades 9-12, with percentage grades earned and credits gained for successfully completed credit courses.
- A list of all grade 11 and 12 courses taken or attempted by the student, with percentage grades earned and the credits gained.
- Identification of any course that has been substituted for one that is a diploma requirement.
- The student's final result on the Ontario Secondary School Literacy Test.
- The student's completion of the community involvement diploma requirement.
- An indication of any extraordinary circumstances affecting the students' achievement in a grade 11 or 12 course.

THE ONTARIO STUDENT RECORD

The Ontario Student Record (OSR) is the official school record for a student. Every Ontario school keeps an OSR for each student enrolled at that school. The OSR contains achievement results, credits earned and diploma requirements completed, and other information important to the education of the student. Students and their parents (if the student is not an adult) may examine the contents of the OSR. These records are protected by the Education Act and the Freedom of Information legislation.

SPECIAL PROGRAMS

RELIGIOUS EDUCATION

A Christian view of life permeates all subjects in Catholic schools. Education in religion is also taught as separate courses each year of secondary school. Every student at St. Paul Catholic Secondary School will participate in a Religious Education Program in each of 4 years of study. Religious Education credit courses shall be those prescribed by the Ontario Conference of Catholic Bishops in the document by the Institute for Catholic Education: Ontario Catholic Secondary Curriculum Policy Document: Religious Education (Revised 2006).

Students are also expected to live the Christian message through prayer, attendance at school liturgies, and through service to others.

ALTERNATIVE EDUCATION PROGRAM

St. Paul offers an alternative learning situation for those students who have great difficulty in the regular school. This program is designed to help students stay in school and to complete their secondary education through a balance of academic credits and work experience through cooperative education.

CREDIT RECOVERY PROGRAM

The Credit Recovery Program is designed for students who are most at risk of falling behind in their credit accumulation and leaving school without an Ontario Secondary School Diploma as a result. The program provides a student who has been unsuccessful in achieving a credit, by not demonstrating evidence of the required skills and knowledge, a second opportunity to meet grade level expectations to achieve the same credit. Eligibility of a student to participate in the program will be determined by the factors which impacted on the student's lack of success the first time through the credit, the student's program pathway, the student's overall academic achievement, and the principal's discretion.

EXTENDED FRENCH PROGRAM

The aim of the Extended French program is to develop students' French-language knowledge and skills and to provide them with an understanding and appreciation of Francophone culture in Canada and around the world. By the end of the four-year program, students will be able to converse freely on familiar topics and will be able to function in a French-speaking community.

St. Paul will grant a certificate in Extended French when a student has successfully completed the sequence of four courses in Extended French and a minimum of three courses in other subjects taught in French.

E-LEARNING

Online learning, or eLearning, is the delivery of programs using the internet. It is a form of learning that is becoming more popular with secondary school students, post-secondary learning institutions and professional learning situations world-wide. Most students will encounter online learning at some point in their academic and/or career future.

Online learning provides a different learning experience for students. Online learning:

- allows students to learn in a more independent and flexible environment.
- supports inquiry and project-based learning.
- increases their technology skill set for future learning.
- assists students in developing the skills needed for future education and/or work.

For more information on accessing online courses, see the Guidance Department.

ALTERNATE YEAR COURSES

In order to improve the variety of courses students may choose to include in their programs, certain courses are offered every other year. Beginning in Grade 10, students should include these options in planning their course selections for the following years.

This coming year: 2016—2017

CHC 2DF	Histoire Canadien
CHW 3M1	World History to the end of the 15th Century
CHI 4U1	Canada: History, Identity & Culture

The following year: 2017 - 2018

BAT 4M1	Principles of Financial Accounting
CGC1DF	Geographie du Canada
CHA 3U1	American History
CHY 4U1	World History: the West & the World
CIA 4U1	Analyzing Current Economic Issues
HRT 3MF	Religions du Monde

LIFESKILLS PROGRAM

Lifeskills is a developmental program which focuses on both academic and practical hands-on work. In this Special Education program, students receive individual attention with academic work which is geared to their level of learning in a non-traditional classroom setting. Integration and co-operative education are considered to be valuable components to this specialized program.

CO-OPERATIVE EDUCATION

Co-operative Education offers senior students the opportunity to gain practical, on-the-job experience while earning credits towards their Ontario Secondary School Diplomas. Whether their post-secondary destination be university, college, apprenticeship or immediate employment, students can use Co-op to explore possible careers. Co-operative Education develops in students the essential work-related knowledge, skills and attitudes that they will need regardless of their career path. A successful Co-op experience strengthens a student's resume and provides them with valuable employee references to accompany their post-secondary educational or work applications.

OYAP

Through the Ontario Youth Apprenticeship Program (OYAP), students can work towards a career in a skilled trade as a registered apprentice, and eventually as a certified skilled worker or journeyperson, while the students are still in high school. Students may register as apprentices and begin their formal apprenticeship training while they earn credits toward their diploma. The hours worked in an apprenticeship placement earn the student Co-operative Education credits as well as hours toward the number required for journeyperson status in the chosen trade. However, the registration of an apprentice is at the discretion of the employer, therefore apprenticeship cannot be guaranteed. Students may continue the apprenticeship after graduating from high school.

DUAL CREDIT PROGRAMS

A dual credit enables students to enroll in a course at a local community college as a temporary student while still enrolled as a secondary school student. Upon successful completion of the course, the student will receive credit from the community college and will be awarded a dual credit by the school. There is no college tuition fee for the course taken.

SPECIALIST HIGH SKILLS MAJOR

The Specialist High Skills Major (SHSM) is a bundle of courses that allows students to focus on a career path that matches their individual skills and interests. Each major is a bundle of courses in a selected field, such as hospitality and tourism, or construction. Students who choose a major learn on the job with employers and at skills training centres, as well as in school. They can earn valuable industry certifications, including first aid and computer technology qualifications. Students also get “reach ahead” opportunities at colleges and/or universities. Students who complete a major can be confident that they leave high school prepared with the knowledge, skills, and industry-recognized qualifications desired by employers, and post-secondary education and training institutions. St. Paul offers a SHSM in Transportation, Health and Wellness, Hospitality and Tourism and Non-Profit. Students interested in this program should contact the Guidance Department

SHSM	MAJOR CREDITS	COOP CREDITS	ADDITIONAL CREDITS IN ENGLISH, MATH, SCIENCE OR BUSINESS
Transportation	4 credits in Automotive	2	3
Health & Wellness	4 credits in Esthetics & Hairstyling	2	3
Hospitality & Tourism	4 credits in Hospitality (Foods)	2	3
Non-Profit	4 credits in Specific Social Science Courses	2	3

BOARD-WIDE PROGRAMS

EXTENDED FRENCH

Programs in Extended French are in place at St. Paul Catholic Secondary School, Trenton, Nicholson Catholic College, Belleville and Regiopolis-Notre Dame Catholic High School, Kingston.

FRENCH IMMERSION

French Immersion is offered at Regiopolis-Notre Dame Catholic High School in Kingston.

INTERNATIONAL BACCALAUREATE PROGRAMME

This academically challenging program is designed for highly motivated university-bound students. The website for the International Baccalaureate Organization contains information on the IB programs and university IB policies. It is available at www.ibo.org. The International Baccalaureate Programme is offered at Nicholson Catholic College, Belleville and Regiopolis-Notre Dame Kingston.

SPECIALIST HIGH SKILLS MAJOR

The following Specialized High Skills Major programs are available within the schools of the Algonquin Lakeshore Catholic District School Board.

St. Paul	Transportation Health & Wellness Hospitality & Tourism Non-Profit
St. Theresa	Transportation Sports Health & Wellness Information & Communication Technology
Nicholson	Transportation Health & Wellness Information & Communication Technology
Holy Cross	Information & Communication Tech.
Regiopolis	Arts and Culture

SUMMER SCHOOL

Summer school courses are offered each year during the month of July. Students register for summer school in late June. Summer school is offered at secondary schools in Belleville and Kingston. Please contact your guidance counselor for more information.

INTERNATIONAL EDUCATION

The Algonquin and Lakeshore Catholic District School Board welcomes many international students into our secondary schools each year. These students come from Asia, Europe, Mexico and South America. Some come to improve their English or experience living in North America. Others plan to pursue Canadian post-secondary opportunities.

English as a Second Language (ESL) courses and student supports are provided as required for English Language Learners (ELL).

EXTRACURRICULAR PROGRAMS

For a relatively small school, St. Paul offers a tremendous number of extra-curricular activities. All students are strongly encouraged to become involved and share their talents and explore new interests.

Academic Pursuits

Mathletes

Model UN General Assembly

Queens Enrichment Programs

Athletic Pursuits - Co-ed

Intramural Activities

Badminton

Cross-Country

Curling

Golf

Skiing

Swimming

Tennis

Track and Field

Athletic Pursuits - Men's and Women's

Baseball

Basketball

Football

Hockey

Rugby

Soccer

Volleyball

Artistic Pursuits

Choir

Concert Band

Drama and Musical productions

Games Club

Human Canvas

Jazz Combo

Grade 7 & 8 Concert Band

Junior Band

Senior Band

Yearbook Club

Community and Social Justice Pursuits

Cardboard City

Dominican Republic Experience

Habitat for Humanity

Just Falcons

Thinkfast

Terry Fox Run

Travel Club

Social Justice Activities

Student Leadership

External Committee

Little N.B.A.

Peer Mentoring

Student Council

STUDENT SERVICES AND SUPPORT

GUIDANCE

The Guidance and Career Education Program is a vital and integral part of the secondary school program. Through the program, students will acquire the knowledge and skills that they need in order to learn effectively, to live and to work cooperatively and productively with a wide range of people, to set and pursue education and career goals, and to carry out their social responsibilities. These goals are outlined in the policy document entitled *Creating Pathways to Success*, 2013.

The Guidance and Career Education Program facilitates this by ensuring that students have access to the learning experiences, personal assistance and information they need in order to succeed. The program is delivered through various means, including classroom instruction, orientation and exit programs, career exploration activities, mentorship programs, peer assistance programs, and individual assistance and short-term counselling.

Students are supported as they make critical decisions regarding career, post-secondary, pathway and course choices. Small group instruction and one on one counselling is provided as needed.

Students and parents are encouraged to participate fully in the programs, workshops, lessons, presentations and individual sessions intended to assist students in moving successfully to their post-secondary destinations. Students may also seek assistance in accessing community agencies and resources. Students and parents may book an appointment by contacting the Guidance Department.

PASTORAL CARE AND CHAPLAINCY

The Chaplaincy Team assists the members of our school community in spiritual growth through counselling, organizing liturgies, providing and supporting opportunities for social justice, and maintaining regular contact with our parish priests.

YOUTH WORKER

The youth worker offers confidential service to students and their families in addressing issues that affect their academic or personal well-being. These concerns may include emotional, social, or behavioral difficulties at school or within the home and community. The youth worker is a member of the Student Services department and works as a liaison with Administration, the Pastoral Care Team, Student Success Team and a wide variety of community agencies.

STUDENT SUCCESS

These programs and strategies are aimed at supporting students who are struggling in secondary school. The Student Success program is essential for credit accumulation and student success in each grade. These programs and strategies:

- help increase students' sense of engagement with school, as well as their level of participation;
- provide varied supports and interventions that meet the needs of the individual student;
- may involve adjustments to enable interdisciplinary teaching and blocking of student timetables;
- involve close monitoring of student attendance and participation;
- may involve specialized support from district school board personnel;

The Student Success team is comprised of administration, guidance counselors, special education teachers, student success teachers and other support staff. The team works with school staff, students, parents and the wider community to ensure that more students earn the credits necessary to graduate. The student success teacher advocates and mentors students, monitors students and develops interventions which may include credit rescue, credit recovery and other opportunities.

The Student Success team also works with the elementary schools to identify at-risk students entering Grade 9. These students may be monitored and/or have their timetables adjusted to facilitate their success in high school.

RESOURCE TEAM

In collaboration with classroom teachers, the Resource staff is responsible for the creation and maintenance of I.E.P.'s for the school's exceptional learners. They offer extra support to students with learning disabilities and their classroom teachers through the Resource Room setting and curriculum support. Resource teachers are responsible for tracking and meeting with exceptional students to monitor academic progress in each subject area and to consult with the Student Success Team regarding students who may require additional monitoring and academic coaching.

SPECIAL EDUCATION

Special Education teachers provide support to exceptional students. Students may be identified as exceptional learners requiring enriched, accommodated or modified evaluations or programs. Students served in this way are often considered exceptional learners, but their needs can be met by the regular subject teacher(s) working in partnership with the Special Education teacher. Input from parents is welcomed and appreciated. Every student who is deemed to be exceptional has an Individual Education Plan (IEP) designed for them. A copy of this IEP is available to parents.

The Board's Special Education Advisory Committee (SEAC) makes recommendations to the Board regarding the establishment and development of Special Education Programs and Services for the exceptional pupils of the Board.

Information regarding Special Education policies and the Special Education Parent Guide can be obtained through the Principal or the Board's Student Services Department.

Program Accommodations and Modifications

Students who are deemed to be exceptional learners are given an Individual Education Plan (I.E.P.). Each student's IEP is unique to them as it provides accommodations and/or modifications that allow the student to more fully function and perform in each class.

Accommodations are supports available to the student which do not alter the expectations of a course, as they are specified in Ministry documents. Examples of possible accommodations include extra time to write tests, using a scribe for written work, reducing the volume of work, and preferential seating for a student.

Modifications are changes made to the grade-level expectations for a subject or course in order to meet a student's learning needs. Modifications may include the use of expectations at a different grade level and/or an increase or decrease in the number and/or complexity of expectations relative to the curriculum expectations for the regular grade level.

Alternative (non-credit) courses are individualized courses, documented in a student's Individual Education Plan (IEP), that comprise alternative expectations—that is, expectations not found in the Ontario curriculum. These courses are usually designed to prepare students for daily living, including employment (supported or independent) and/or community living.

PEER MENTORS

Senior students are selected as peer mentors and volunteer their time and skills over the course of one or possibly two school years. These students are selected to form the peer mentor team based on their leadership potential and their credibility with peers in the school. They receive training in strategies to mediate disputes and in effective communication and meet on a regular basis with a teacher advisor and school administration.

Within the school the peer mentors work to encourage positive social behaviours each day by engaging students in conversation who appear to need support, speaking to students who are acting inappropriately and providing an example of respectful, mature social interactions. The peer mentors pay particular attention to all students new to St. Paul including all Grade 9s and meet on a one to one basis with each student to ensure that all aspects of their high school experience are going well. The mentors meet with Grade 9 students assigned to them several times throughout the year and are sought out by the students to assist them with problems when needed.

LIBRARY\LEARNING COMMONS

The SPCSS library is currently in transition to the modern library learning commons. We are a full-service learning, research and project space. We are a flexible environment built to accommodate multiple learning activities including areas for group meetings, tools to support creative efforts and teacher-librarians to provide help as needed. The space accommodates class visitations for instruction and project work, individual research, study and leisure reading. The learning commons is equipped with laptops, tablets and e-readers for student use. As well, in accordance with the “bring your own device” policy, students are encouraged to utilize their own technology while in the library learning commons. We have a wide range of print and non-print materials including access to Gale research databases and e-books. The electronic materials are also available online on our webpage. The library learning commons staff and classroom teachers, work together to provide students with frequent opportunities to develop valuable research strategies and essay writing skills. We have set aside a reading area and have actively promoted and purchased a significant number of contemporary fiction and non-fiction books. Students are welcome in the library learning commons before and after school as well as lunch hour.

INFORMATION TECHNOLOGY

In addition to the computers available in the Library-Learning Commons, students have access to computer labs for student work. St. Paul is also using technology to meet the needs of learning disabled students. Our Resources Room has computers dedicated to the needs of these students, including Kurzweil Reader, Text-to-Voice Conversion software, Dragon Naturally Speaking and prewriting software. Students are trained and supported to use this software throughout their studies at St. Paul. Students have access to computers before and after school and at lunch.

SCHOOL ADVISORY COUNCIL

School Council provides an exciting way to contribute to the education of the students at St. Paul. Involvement in School Council gives parents the opportunity to strengthen the partnership among parents, students, teachers, principal, school boards, government and the community. All parents/guardians are automatic members of School Council and are invited to join this dedicated team.

THE HOME ROOM PROGRAM

Each home room consists of approximately 20 students from different grades who meet with a homeroom teacher at the start of every school day. Ideally, these students will stay together with the same homeroom teacher for their whole career. This arrangement provides the best opportunity for our home room teachers to develop the on-going relationships with students that enables teachers to act as advisers, mentors, coaches, referral agents and advocates for them. Our homeroom teachers provide support and give direction to students as they achieve their personal goals, which in turn helps students make positive contributions to the community of St. Paul and the achievement of our shared goals.

The goals of our home room program are as follows:

- to build the community of St. Paul,
- to foster school spirit, and
- to have fun.

DIPLOMA INFORMATION

THE ONTARIO SECONDARY SCHOOL DIPLOMA

In order to earn the OSSD, a student must:

1. earn 30 credits, including 18 compulsory credits.
2. complete 40 hours of community involvement activities.
3. successfully complete the Ontario Secondary School Literacy test or course.

The 30 credits, including 18 compulsory credits, are distributed as follows:

- 4 credits in English (1 credit per grade)
 - 1 credit in French as a second language
 - 3 credits in Mathematics (at least 1 credit in Grade 11 or 12)
 - 2 credits in Science
 - 1 credit in Canadian History
 - 1 credit in Canadian Geography
 - 1 credit in the Arts
 - 1 credit in Health and Physical Education
 - .5 credit in Civics
 - .5 credit in Career Studies
- plus
- 1 additional credit in health and physical education, or the arts, or business studies or French as a second language or co-operative education
 - 1 additional credit in science (Grade 11 or 12) or technological education or French as a second language or computer studies or co-operative education
 - 1 additional credit in English or French as a second language or a third language or a social science and the humanities or Canadian and world studies or guidance and career education or co-operative education

It is the policy of the Algonquin and Lakeshore Catholic District School Board that, with the exception of allowances provided for by the Ministry of Education, the Education Act or by this policy, all full time students who are enrolled in secondary school will take a credit course in religious education in each of their four years of attendance.

A credit is granted in recognition of the successful completion of a course for which a minimum of 110 hours has been scheduled. All courses have a credit value of one unless otherwise stated (e.g. Co-operative Education, Civics, Career Studies).

Secondary school students who transfer from one Ontario school to another will have their credits transferred to the new school. Students who enroll in this system from a school outside Ontario will have their previous records assessed through the Student Services Department. Final approval for previous credits is the responsibility of the Principal.

THE ONTARIO SECONDARY SCHOOL CERTIFICATE

The Ontario Secondary School Certificate will be granted on request to students who leave school before earning the Ontario Secondary School Diploma, provided that they have earned a minimum of 14 credits distributed as follows:

- 2 credits in English
- 1 credit in Canadian Geography or Canadian History
- 1 credit in Mathematics
- 1 credit in Science
- 1 credit in Health and Physical Education
- 1 credit in the Arts or Technological Education
- 7 additional credits

Students may earn the Ontario Secondary School Certificate without completing the 40 hours of community involvement or successfully completing the Ontario Secondary School Literacy Test.

THE CERTIFICATE OF ACCOMPLISHMENT

Students who leave school before fulfilling the requirements for the Ontario Secondary School Diploma or the Ontario Secondary School Certificate may be granted a Certificate of Accomplishment. The Certificate of Accomplishment may be a useful means of recognizing achievement for students who plan to take certain vocational programs or other kinds of further training, or who plan to find employment after leaving school. The Certificate of Accomplishment will be accompanied by the student's Ontario Student Transcript. For those students who have an IEP, a copy of the IEP may be included.

There are no compulsory credits required for this certificate. Students may earn the Certificate of Accomplishment without completing the 40 hours of community involvement or successfully completing the Ontario Secondary School Literacy Test.

SUBSTITUTIONS FOR COMPULSORY COURSES

To meet individual students' needs, the Principal may replace up to three compulsory credit courses with courses from the remainder of those that meet the compulsory credit requirements. The decision to make a substitution for a student will be made only if the student's educational interests are best served by such a substitution. The Principal will determine whether or not a substitution should be made in consultation with parents or the adult student and appropriate school staff. Each substitution will be noted on the student's Ontario Student Transcript.

COMMUNITY INVOLVEMENT ACTIVITIES

Students must complete a minimum of 40 hours of community involvement activities as part of the requirements for an Ontario Secondary School Diploma (OSSD). The purpose of the community involvement requirement is to encourage students to develop awareness and understanding of civic responsibility and of the role they can play and the contributions they can make in supporting and strengthening their communities. Students may complete the requirement at any time starting in the summer preceding grade 9 and finishing in their graduating year. Students, in collaboration with their parents, will decide how they will complete the community involvement requirement. Community involvement activities may take place in a variety of settings, including not-for-profit organizations, public sector institutions (including hospitals), and informal settings. Students may not fulfill the requirement through activities that are counted towards a credit (cooperative education and work experience, for example), through paid work, or by assuming duties normally performed by a paid employee. The requirement is to be completed outside normal instructional hours – that is, the activities will take place during lunch hours, after school, on weekends, or during school holidays.

Students will maintain and provide documentation of their community involvement activities. Copies of the Community Involvement Record are available in the Guidance office. A list of eligible and ineligible activities is provided on the back of the Record. Completion of activities must be confirmed on the Record by the organizations or persons supervising the activities. Upon completion of the 40-hour requirement, the Community Involvement Record must be submitted to the Principal by the student. The Record must identify the name of the person or organization receiving the service, the activity performed, the dates and hours, the signatures of the student and his or her parents, and a signed acknowledgement by the person (or a representative of the organization) involved. The Principal will decide whether the student has met the requirements of both the ministry and the board for these activities. Any community hours accumulated through activities at St. Paul must be submitted by the end of the school year in which the activities were done.

THE ONTARIO SECONDARY SCHOOL LITERACY TEST (OSSLT)

Students must successfully complete the Ontario Secondary School Literacy Test in order to earn a secondary school diploma. When they are in Grade 10, students will take the OSSLT which is based on the Ontario curriculum expectations for language and communication – particularly reading and writing – up to and including Grade 9.

Accommodations

The necessary accommodations will be made to ensure that students who are receiving special education programs and services and who have an Individual Education Plan (IEP) have a fair and equal opportunity to successfully complete the OSSLT. Students needing such accommodations may or may not have been formally identified as exceptional by an Identification, Placement, and Review Committee (IPRC). The accommodations made will be the same as those that are set out in the student's IEP and/or that are available to including examinations and other forms of evaluation. While accommodations such as alternative forms of print and extra time are acceptable, the actual content of the OSSLT cannot be altered.

Deferrals

Students who might benefit from a deferral of the test may include students who have been identified as exceptional and students registered in English as a second language/English literacy development (ESL/ELD) courses, who have not yet acquired the level of proficiency in English required for successfully completing the test.

Exemptions

Students whose IEP indicates that the student is not working towards the attainment of a secondary school diploma may, with parental consent and the approval of the Principal, be exempted from participating in the OSSLT. Students who do not successfully complete the literacy test will not be able to receive a secondary school diploma. Should the learning expectations contained in the student's IEP be revised at some point so as to allow the student to work towards the attainment of the secondary school diploma, the student would be expected to successfully complete the OSSLT.

THE ONTARIO SECONDARY SCHOOL LITERACY COURSE (OSSLC)

This course is designed to help students acquire and demonstrate the cross-curricular literacy skills that are evaluated by the Ontario Secondary School Literacy Test (OSSLT). To be eligible for the course, a student must have written and failed the OSSLT. Policy requirements for taking the OSSLC are contained in the curriculum policy document *The Ontario Curriculum: English, The Ontario Secondary School Literacy Course (OSSLC), Grade 12, 2003*. Students who pass the course are considered to have met the literacy graduation requirement.

THE ADJUDICATION PROCESS

As part of the Adjudication process, school boards may establish adjudication panels at the end of the school year to provide certain students with an additional opportunity to meet the literacy graduation requirement. These students include those who would otherwise be eligible to graduate in June but, through no fault of their own, have not been able to take advantage of the normal opportunities to write the OSSLT and/or have not been able to enroll in or complete the OSSLC, owing to unforeseen circumstances. Also eligible for the adjudication process are students who were receiving special education programs or services, and who had an IEP documenting required accommodations, but owing to unforeseen circumstances, did not have access to these accommodations when they were taking the OSSLT. Please contact your Guidance Counsellor to determine if you are eligible for the Adjudication Process.

DESTINATION PATHWAYS

Program Pathways

A student's program pathway consists of a comprehensive and integrated set of courses, supports and experiences that can be spread over a number of semesters or years that will lead a student toward postsecondary destinations that include apprenticeship, college, workplace, community living or university. A program pathway should reflect the goals that motivate the student to complete secondary school. Personalizing a school-designed program pathway by including courses of interest and areas of specialization can maximize student engagement, build confidence and assist in planning for success.

"Pathways thinking" encourages students and parents to "begin with the end in mind" and investigate, select, and sequence courses, supports, and experiences in ways that maximize students' opportunities for a successful outcome. Program pathways provide students and their families with a greater variety and a wider range of program options than have been previously available.

School-designed program pathways have built-in flexibility and transition points so that students can move from one course type to another or from one program pathway to another. Students may change or revise their program pathway as appropriate to their developing needs and interests.

Examples of possible program pathways can be found on the following pages.

On the following pages are six "destination pathways" that are designed with a specific post-secondary destination in mind. These pathways are only suggestions to assist students in planning their courses in order to reach their chosen destination.

Students are responsible for ensuring that their course selections fulfill the requirements for their specific university, college or apprenticeship program requirements.

University - Math/Science/Engineering/Health/Business

Grade 9		Grade 10		Grade 11		Grade 12	
Religion	1O	Religion	2O	Religion	3M	Religion	4M
English	1D/1P	English	2D	English	3U	English	4U
Math	1D/1P	Math	2D	Functions	3U	Adv. Functions	4U
		*transfer course req'd from gr. 9 applied Math				Calculus & Vectors	4U
Geography	1D/1P	History	2D/2P				
Science	1D/1P	Science	2D	Minimum of 2 Sciences EACH year Suggested combinations: Engineering: Physics 3U & 4U and Chemistry 3U & 4U Math: Physics 3U & 4U and any other Science 3U & 4U Health: Chemistry 3U & 4U and Biology 3U & 4U Science: Chemistry 3U & 4U and any other Science 3U & 4U			
French	1D/1P	Careers/Civics	2O				
Arts*		Business or Arts					
		Or Phys. Ed*					
Phys. Ed*		Technology*					

*These courses need not be taken in the year indicated; they can be moved to allow for more flexibility.

University - Social Sciences/Humanities

Grade 9	Grade 10	Grade 11	Grade 12
Religion 1O	Religion 2O	Religion 3M	Religion 4M
English 1D/1P	English 2D	English 3U	English 4U
Math 1D/1P	Math 2D *transfer course req'd from gr. 9 applied Math	Functions & Applications 3M	Data Management 4U
Geography 1D/1P	History 2D/2P		
Science 1D/1P	Science 2D	Science 3U/3C or Technology 3U/3M/3C	
French 1D/1P	Careers/Civics 2O	or Co-Op COOP	
Arts*	Business or Arts Or Phys. Ed*		
Phys. Ed*	Technology*		

*These courses need not be taken in the year indicated; they can be moved to allow for more flexibility.

College - Science/Technology/Health

Grade 9	Grade 10	Grade 11	Grade 12
Religion 1O	Religion 2O	Religion 3O/3M	Religion 4O/ 4M
English 1D/1P	English 2P	English 3C	English 4C
Math 1D/1P	Math 2D/2P	Functions & Applications 3M	Math for College Technology 4C
Geography 1D/1P	History 2D/2P		English: Business/ Technology 4O
Science 1D/1P	Science 2D/2P	Biology 3C (for Health students)	Chemistry* 4C
French 1D/1P	Careers/Civics 2O		Physics* 4C (for Science/Technology students)
Arts*	Business or Arts Or Phys. Ed*	Technology* 3M	Cooperative Education*
Phys. Ed*	Technology*		

* These courses need not be taken in the year indicated; they can be moved to allow for more flexibility.

College - Non-Technical

Grade 9	Grade 10	Grade 11	Grade 12
Religion 10	Religion 20	Religion 30/3M	Religion 40/ 4M
English 1D/1P	English 2P	English 3C	English 4C
Math 1D/1P	Math 2P	College Math 3C	College Math 4C
Geography 1D/1P	History 2D/2P		
Science 1D/1P	Science 2D/2P	Science* 3C/4C or Technology* 3M	
French 1D/1P	Careers/Civics 20	or Co-Op * COOP	Co-Op * COOP
Arts*	Business or Arts Or Phys. Ed*		
Phys. Ed*	Technology*		

* These courses need not be taken in the year indicated; they can be moved to allow for more flexibility.

Apprenticeship

Grade 9	Grade 10	Grade 11	Grade 12
Religion 10	Religion 20	Religion 30	Religion 40
English 1D/1P	English 2D/2P	English 3C	English 4C
Math 1D/1P	Math 2D/2P	Foundations for College Math 3C Or Functions/Applications 3M	Foundations for College Math 4C Or Math for College Technology 4C
Geography 1D/1P	History 2D/2P		English: Business/Tech 4O
Science 1D/1P	Science 2P	Chemistry* 4C	Physics * 4C
French 1D/1P	Careers/Civics 2O	Cooperative Education (highly recommended)	Cooperative Education (highly recommended)
Arts*	Business or Arts Or Phys. Ed*		
Phys. Ed*	Technology*	Technology* 3M	Technology* 3M/4M

* These courses need not be taken in the year indicated; they can be moved to allow for more flexibility.

Workplace

There are a limited number of college programs available to students with workplace credits. Please see your guidance counsellor for more information.

Grade 9	Grade 10	Grade 11	Grade 12
Religion 1O	Religion 2O	Religion 3O	Religion 4O
English 1P/1L	English 2P/2L	English 3E	English 4E
Math 1P/1L	Math 2P/2L	Math: Everyday Life 3E	
Geography 1P	History 2P	Science* 3E/3C/4C Or Technology* 3M	
Science 1P/1L	Science 2P/2L	Cooperative Education (highly recommended)	Cooperative Education (highly recommended)
French 1P	Careers/Civics 2O		
Arts*	Business or Arts Or Phys. Ed*		
Phys. Ed*	Technology*		

***These courses need not be taken in the year indicated; they can be moved to allow for more flexibility.**

COURSE INFORMATION

COURSE DESCRIPTIONS

The courses offered by this school have been developed according to the requirements of the Ontario Ministry of Education and Training. The courses in Religion are based on the guidelines provided by the Ontario Council of Catholic Bishops.

All courses of study are on file at the school. Upon request to the Principal, students and parents may examine course outlines at the school.

All subjects are designated by a six character code consisting of three letters followed by a number, letter and another number. The first three characters indicate the subject course code as indicated in the Ministry of Education documents

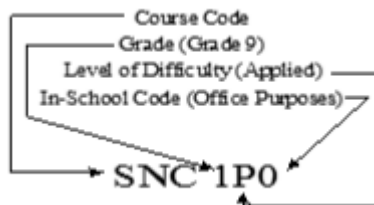

The fourth character indicates the grade.

- 1 = Grade 9
- 2 = Grade 10
- 3 = Grade 11
- 4 = Grade 12

The fifth character indicates the course type.

- C = College preparation (Grades 11 and 12)
- D = Academic (Grades 9 and 10)
- E = Workplace preparation (Grades 11 and 12)
- L = Locally Developed (Grades 9 and 10)
- M = University/College preparation (Grades 11 and 12)
- O = Open (Grades 9 to 12)
- P = Applied (Grades 9 and 10)
- U = University preparation (Grades 11 and 12)

COURSE LOAD

Students in Grades 9, 10 and 11 must carry a full course load, which is 4 credits per semester. Students in Grade 12 must carry a minimum of 3 courses per semester. Students entering Grade 12 who have not achieved 24 credits are not entitled to a spare unless he/she has met with a guidance counsellor and Administrator to outline an alternate, acceptable plan for meeting graduation requirements in a timely fashion. In cases where students desire to return for a fifth year, students will meet with an Administrator to review the academic rationale. Students returning for a 5th year should refer to “The Fifth Year Program” on page 3 for course load information.

COURSE LEVELS OF DIFFICULTY

The level of a course refers to the specific demands of the material and its methods of presentation that differentiate it from other courses in that subject in that year. Within a subject area, courses will be offered requiring different levels of difficulty for successful completion. A student should choose a course requiring a level of aptitude best meeting his/her needs and interests in that particular subject, keeping in mind his/her previous achievement in that subject area and his/her proposed educational plans for the future.

Students in Grades 9 and 10 select an appropriate combination of academic, applied, locally developed and open courses in order to add to their knowledge and skills base, explore their interests, and determine the type of educational program they are best suited to undertake in Grades 11 and 12.

In Grades 11 and 12, students select courses designed to prepare them for a particular post-secondary destination, whether it be university, college, apprenticeship or workplace. Open courses are also available in Grades 11 and 12.

REQUIRED COURSES

To ensure that diploma requirements are met and prerequisites are satisfied, students must select, at an appropriate level, these courses as follows:

Grade 9

Religion
English
Mathematics
Science
Canadian Geography
French
2 electives*

Grade 10

Religion
English
Mathematics
Science
Canadian History
Civics (.5)
Career Studies (.5)
2 electives*

*keeping in mind diploma requirements; by the end of Grade 10, students should have at least one Arts credit and one Phys. Ed. credit.

Grade 11

Religion
English
Mathematics
5 electives*

Grade 12

Religion
English
4-6 electives*

*keeping in mind diploma requirements and post-secondary admission requirements

COURSE PREREQUISITES

A prerequisite course is a course that is deemed absolutely essential for the successful understanding and completion of a subsequent course. Prerequisite courses are established only by ministry curriculum policy documents and are identified in course descriptions. Requests for individual consideration where prerequisites are not met will be directed to the Principal. It is ultimately the responsibility of the student to ensure that the prerequisite courses are successfully completed before enrolling in the subsequent course.

COURSE FEES

Fees may be charged for some courses for consumable items (Visual Arts, Communications Technology) or for excursions which are an enrichment of the course (Phys. Ed.). While no fees will be charged for texts, students are responsible for the cost of replacing a lost or damaged text book. Students are expected to provide all other learning materials, including workbooks where required. Students may be required to provide their own transportation to and from Co-op placements.

COURSE CHANGES AND WITHDRAWALS

Students wishing to change a course must consult with a guidance counsellor. Course transfers are possible if made within the first two weeks of a semester but are dependent upon available space in the appropriate classes. Students must follow their established timetable in its entirety until any changes have been officially approved.

If a grade 12 student is carrying a full course load of 4 credits, he/she may withdraw from a course without that course showing on the Ontario Student Transcript, as long as this is completed within 5 days after the issue of the mid-term report. After that time, the course would be indicated by a "W" on the OST to indicate withdrawal from the course. The mark at the time of withdrawal would also be indicated on the student's transcript.

If a 5th year student desires a course change, then that change must be in keeping with the distinct academic plan which was reviewed in the spring prior to his/her return to secondary school in order to be considered.

RELIGIOUS EDUCATION

Every student at St. Paul Catholic Secondary School will participate in a Religious Education Program in each of their four years of high school, in accordance with the Algonquin and Lakeshore Catholic District School Board's Secondary School Religious Education Policy Statement and Practice.

COURSES OFFERED THROUGH OTHER MEANS

The majority of students earn all of the necessary credits for the Ontario Secondary School Diploma through a regular day school program. Under certain circumstances a student may be granted permission to take an online course. This alternative is only applicable when:

- (1) the course is not offered all year in the day school program,
- (2) the course does not fit into the student's timetable, (3) the course is the last one needed for graduation,
- (4) the student maintains a full course load at day school and is passing all courses on his/her timetable.

Any credit earned outside of a regular day school program will be noted as such on the Ontario Student Transcript.

It is the student's responsibility to see that his/her guidance counsellor has updated grades available to submit to the Ontario Universities' Application Centre and/or the Ontario College Application Service and that final grades are submitted to his/her guidance counsellor by the end of the first week of June for graduation purposes.

PRIOR LEARNING ASSESSMENT RECOGNITION

Students may obtain credits towards the Ontario Secondary School Diploma (OSSD) for knowledge and skills that they have acquired outside of secondary school. This prior learning is assessed and evaluated to determine whether the student has met the provincial course expectations. Students may 'challenge' a specific course for credit if they can provide evidence indicating a likelihood of success.

The student should be prepared to provide reasonable evidence for success in the challenge process (eg., a portfolio, documentation of related course work, recommendation from a teacher, etc.). Further, the student will be required to demonstrate achievement of the course expectations through formal tests and other assessment strategies appropriate for the particular course. Students who are successful in the challenge assessment will receive a final percentage grade and a credit for the course.

Students who are eligible for equivalency credits are those who transfer to Ontario secondary schools from non-inspected private schools or schools outside Ontario. See your guidance counselor for more details regarding PLAR.

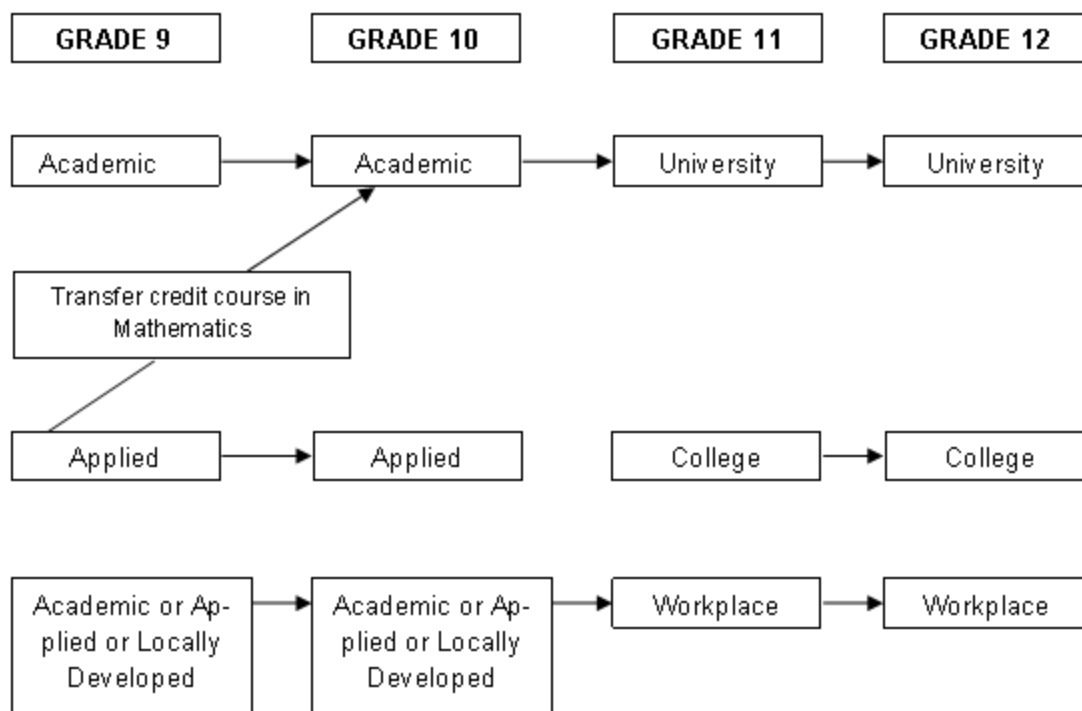

Academic Courses (D)

These courses develop students' knowledge and skills through the study of theory and abstract problems. They focus on the essential concepts of a subject and explore related concepts as well. They incorporate practical applications as appropriate. Academic courses are recommended for students planning to proceed to university preparation courses (U or M) in Grades 11 and 12.

Applied Courses (P)

These courses focus on the essential concepts of a subject, and develop students' knowledge and skills through practical applications and concrete examples. Familiar situations are used to illustrate ideas, and students are given more opportunities to experience hands-on applications of the concepts and theories they study. Applied courses are recommended for students planning to proceed to college preparation courses (C or M) in Grades 11 and 12.

Open Courses (O)

These courses allow students to broaden their knowledge and skills in a particular subject that may or may not be directly related to their postsecondary goals, but that reflects their interests. These courses are appropriate for all students regardless of postsecondary destination.

University Preparation Courses (U)

These courses are designed to equip students with the knowledge and skills they need to meet the entrance requirements for university programs. Teaching and learning will emphasize theoretical aspects of the course content but will also include concrete applications. Courses will emphasize the development of both independent research skills and independent learning skills. Students will also be required to demonstrate that they have developed these skills.

University/College Preparation Courses (M)

University/college preparation courses include content that is relevant for both university and college programs. These courses are designed to equip students with the knowledge and skills they need to meet the entrance requirements for specific university and college programs. Teaching and learning will emphasize both theoretical aspects and related concrete applications of the course content. Courses will emphasize the development of both independent research skills and independent learning skills. Students will also be required to demonstrate that they have developed these skills.

College Preparation Courses (C)

College preparation courses are designed to equip students with the knowledge and skills they need to meet the entrance requirements for college programs. Teaching and learning will emphasize concrete applications of the theoretical material covered in the course, and will also emphasize the development of critical-thinking and problem-solving skills. Courses will emphasize the development of both independent research skills and independent learning skills. Courses will also require students to demonstrate that they have developed these skills.

Workplace Preparation Courses (E)

Workplace preparation courses are designed to equip students with the knowledge and skills they need for direct entry into the workplace or for admission to apprenticeship programs and other training programs offered in the community. Teaching and learning will emphasize workplace applications of the course content, but will also explore the theoretical material that underlies these practical applications. Courses will emphasize the development of generic employment skills, as well as independent research and learning skills. Students will be required to demonstrate that they developed these skills. Workplace preparation courses in particular should also promote and stress the importance of lifelong learning.

Locally Developed Courses (L)

Locally developed compulsory credit courses are intended for grade 9 and 10 students whose educational needs are not met by the academic or applied level courses. They prepare students for further study in English, Mathematics, and Science at the workplace level in grades 11 and 12. A student may count up to six locally developed courses in English, Math and Science as compulsory courses.

Alternative Courses (K)

Alternative courses, at the secondary school level, are non-credit courses. The course expectations in an alternative course are individualized for the student and generally focus on preparing the student for daily living. Alternative expectations are developed to help students acquire knowledge and skills that are not represented in the Ontario curriculum. Examples of alternative programs include: speech remediation, social skills, orientation/mobility training, and personal care programs. For the vast majority of students, these programs would be given in addition to modified or regular grade-level expectations from the Ontario curriculum.

Transfer Courses

Students who successfully complete the Grade 9 academic mathematics course may proceed to either the Grade 10 academic or the Grade 10 applied mathematics course. Those who successfully complete the Grade 9 applied course may proceed to the Grade 10 applied course, but must successfully complete a transfer course if they wish to proceed to the Grade 10 academic mathematics course. This transfer course is made available to offer students a means of transferring from the Grade 9 applied to the Grade 10 academic mathematics course. It has been designed as a half-credit course.

The student who enrolls in this transfer course has decided to change from the applied course type in Grade 9 to the academic course type in Grade 10. In many cases, the student will have decided to pursue a program pathway in Grades 11 and 12 that requires the Grade 10 academic mathematics course.

COURSE PROGRAM DESCRIPTIONS

RELIGION

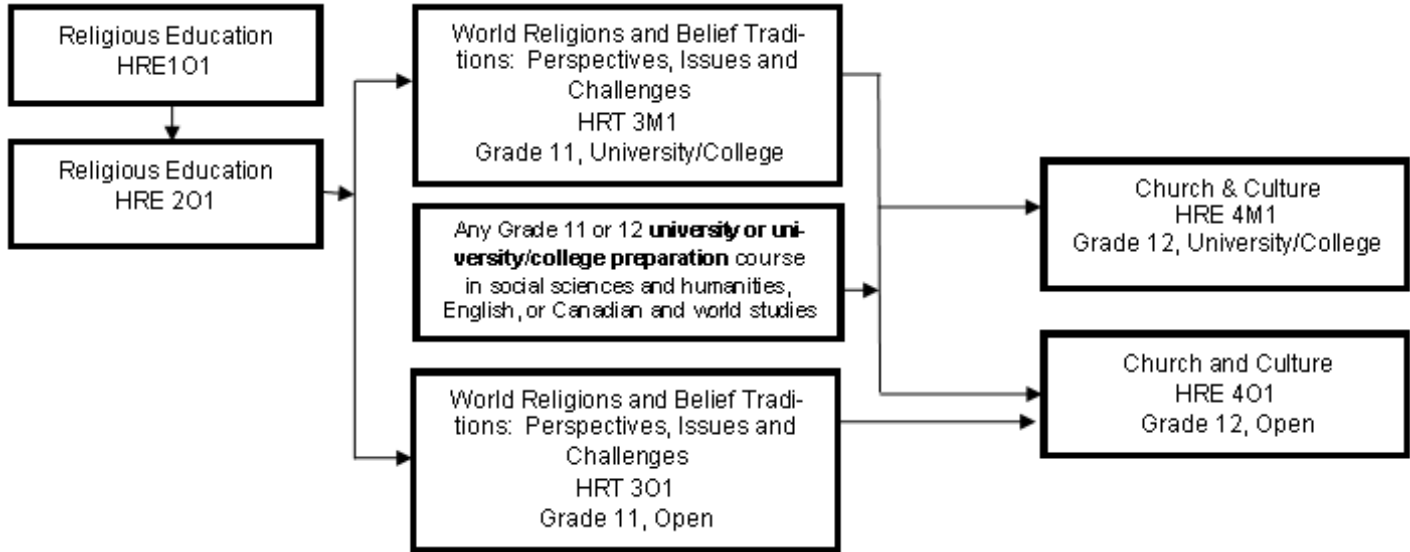

RELIGIOUS EDUCATION

Grade 9 - Open

HRE 101

This course invites students to a deeper understanding of both the joy and the demands of following in the way of Christ and living out the call to discipleship as it is described in the Scriptures. Using the Beatitudes as a touchstone, students examine the attitudes and actions that characterize the Christian life. Students will explore a variety of topics related to the themes of personhood, interpersonal relationships and sexuality. They are encouraged to understand and nurture within themselves the virtues which will enable them to deepen their relationship with God in and through Christ in the context of a Spirit filled community.

Pre-requisite: None

RELIGIOUS EDUCATION

Grade 10 - Open

HRE 201

This course both invites and challenges the adolescent to personalize the principles that guide Catholics in understanding their role in shaping culture through our discipleship. The exploration of these principles starts with the Scriptural foundations to the questions of what it means to be human and how God has and continues to shape our humanity through culture. The principles are then developed through the Gospel themes that reveal how Jesus' Kingdom of God is expressed in all of our relationships: to ourselves, to others, to our civil society, to our Church, and to our Global community.

Pre-requisite: None

WORLD RELIGIONS AND BELIEF TRADITIONS : PERSPECTIVES, ISSUES AND CHALLENGES

Grade 11 - University/College Preparation

HRT 3M1

This course provides students with opportunities to explore various world religions and belief traditions. Students will develop knowledge of the terms and concepts relevant to this area of study, will examine the ways in which religions and belief traditions meet various human needs, and will learn about the relationship between belief and action. They will examine sacred writings and teachings, consider how concepts of time and place influence different religions and belief traditions, and develop research and inquiry skills related to the study of human expressions of belief.

Prerequisite: None

WORLD RELIGIONS AND BELIEF TRADITIONS IN DAILY LIFE

Grade 11 - Open

HRF 3O1

This course enables students to study world religions and belief traditions in local, Canadian, and global contexts. Students will explore aspects of the human quest for meaning and will examine world religions and belief traditions as exemplified in various sacred teachings and principles, rites, and passages. They will also study the interaction throughout history between society and various belief traditions, and will have opportunities to develop research and inquiry skills related to the study of world religions and belief traditions.

Prerequisite: None

CHURCH AND CULTURE

Grade 12 - University/College Preparation

HRE 4M1

This course is directed toward the clear identification of Catholic moral principles and the concrete application of these principles in the lives of students. The course proceeds from foundational beliefs rooted in Sacred Scripture concerning justice and peace to an exploration of the principles that shape Christian life. In the Family Life Education strand, students explore a variety of topics related to the themes of personhood, interpersonal relationships and sexuality. Special attention is given to the interaction between Church and culture. This course is intended to prepare the senior students for the lifelong task of the Christian moral life: The call to follow Jesus, to believe in His redemptive love for mankind and to proclaim and incarnate the reign of God as begun by Jesus Christ.

Prerequisite: Any Grade 11 or 12 university of university/college preparation course in social science and humanities, English or Canadian and world studies.

CHURCH AND CULTURE

Grade 12 - Open

HRE 401

This course assists students in their development of the skills and knowledge necessary to live lives of full maturity. Within the Catholic faith tradition, it is believed that this growth towards human maturity is best served when students are able to define themselves authentically towards other people and to their God, to others and to their world. In the Family Life Education strand, students explore a variety of topics related to the theme of personhood, interpersonal relationship and sexuality. Students will demonstrate acknowledgement of the prophetic tradition in Scripture, become familiar with the social teachings of the Catholic Church, explore contemporary notions of spirituality and prayer, and recognize the importance, power, and potential of the human person in relation to morality and personal choices concerning future life paths.

Prerequisite: None

THE ARTS

DRAMATIC ARTS

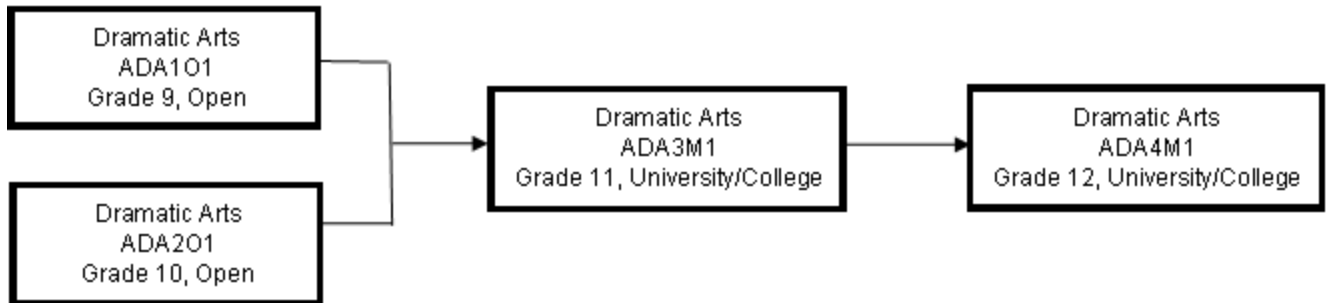

DRAMATIC ARTS

Grade 9 - Open

ADA 101

This course provides opportunities for students to explore dramatic forms and techniques, using material from a wide range of sources and cultures. Students will use the elements of drama to examine situations and issues that are relevant to their lives. Students will create, perform, discuss, and analyse drama, and then reflect on the experiences to develop an understanding of themselves, the art form, and the world around them.

DRAMATIC ARTS

Grade 10 - Open

ADA 201

This course provides opportunities for students to explore dramatic forms, convention, and techniques. Students will explore a variety of dramatic sources from various cultures and representing a range of genres. Students will use the elements of drama in creating and communicating through dramatic works. Students will assume responsibility for decisions made in the creative and collaborative processes and will reflect on their experiences. Prerequisite: None

DRAMATIC ARTS

Grade 11 - University/College Preparation

ADA 3M1

This course requires students to create and perform in dramatic presentations. Students will analyse, interpret, and perform dramatic works from various cultures and time periods. Students will research various acting styles and conventions that could be used in their presentations, and analyse the functions of playwrights, directors, actors, designers, technicians, and audiences. Prerequisite: ADA 101 or ADA 201

DRAMATIC ARTS**Grade 12 - University/College Preparation****ADA 4M1**

This course requires students to experiment individually and collaboratively with forms and conventions of both drama and theatre from various cultures and time periods. Students will interpret dramatic literature and other texts and media sources while learning about various theories of directing and acting. Students will examine the significance of dramatic arts in various cultures, and will analyse how the knowledge and skills developed in drama are related to their personal skills, social awareness, and goals beyond secondary school. Prerequisite: ADA 3M1

MUSIC

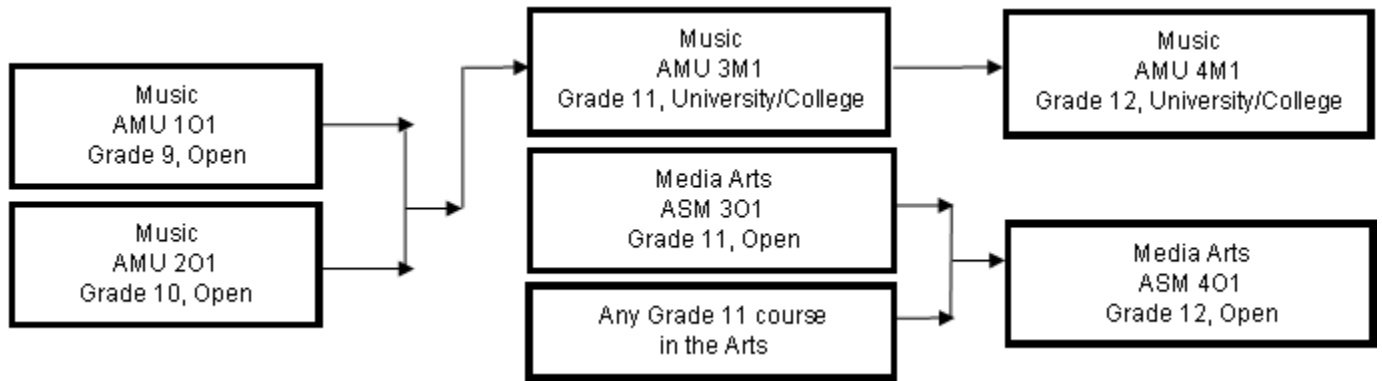

MUSIC

Grade 9 - Open

AMU 101

This course emphasizes the creation and performance of music at a level consistent with previous experience and is aimed at developing technique, sensitivity, and imagination. Students will develop musical literacy skills by using the creative and critical analysis processes in composition, performance, and a range of reflective and analytical activities. Students will develop an understanding of the conventions and elements of music and of safe practices related to music, and will develop a variety of skills transferable to other areas of their life.

Prerequisite: None

MUSIC

Grade 10 - Open

AMU 201

This course emphasizes the creation and performance of music at a level consistent with previous experience. Students will develop musical literacy skills by using the creative and critical analysis processes in composition, performance, and a range of reflective and analytical activities. Students will develop their understanding of musical conventions, practices, and terminology and apply the elements of music in a range of activities. They will also explore the function of music in society with reference to the self, communities and cultures.

Prerequisite: None

MUSIC

Grade 11 - University/College Preparation

AMU 3M1

This course provides students with opportunities to develop their musical literacy through the creation, appreciation, analysis, and performance of music, including traditional, commercial, and art music. Students will apply the creative process when performing appropriate technical exercises and repertoire and will employ the critical analysis processes when reflecting on, responding to, and analysing live and recorded performances. Students will consider the function of music in society and the impact of music on individuals and communities. They will explore how to apply skills developed in music to their life and careers.

Prerequisite: AMU101 or AMU 201

MEDIA ARTS

Grade 11 - Open

ASM 301

This course enables students to create media art works using available and emerging technologies such as computer animation, digital imaging, video, and a variety of media. Students will explore the elements and principles of media arts, the connections between contemporary media art works and traditional art forms, and the importance of using responsible practices when engaged in the creative process. Students will develop the skills necessary to create and interpret media art works. At St. Paul, students in this course will:

manipulate audio, video and photography using industry standard software; visit specialized colleges - discover new options; use Protools (audio software), iMovie, Photoshop; work and learn in St. Paul's iMac computer lab daily.

Prerequisite: None

MEDIA ARTS

Grade 12 - Open

ASM 4E1

This course emphasizes the development of the knowledge and skills required for the production of interactive media art forms (e.g., interactive art installations, interactive videos, simulations, network art). Students will analyse and evaluate media art works, and will create their own works using a variety of technologies and processes (e.g., computer graphics, photo-imaging, digital video production techniques, electro-acoustics). Students will maintain a portfolio of their media art works.

Prerequisite: Any Grade 11 course in the arts

MUSIC

Grade 12 - University/College Preparation

AMU 4M1

This course enables students to enhance their musical literacy through the creation, appreciation, analysis, and performance of music. Students will perform traditional, commercial, and art music, and will respond with insight to live and recorded performances. Students will enhance their understanding of the function of music in society and the impact of music on themselves and various communities and cultures. Students will analyse how to apply skills developed in music to their life and careers.

Prerequisite: AMU 3M1

VISUAL ARTS

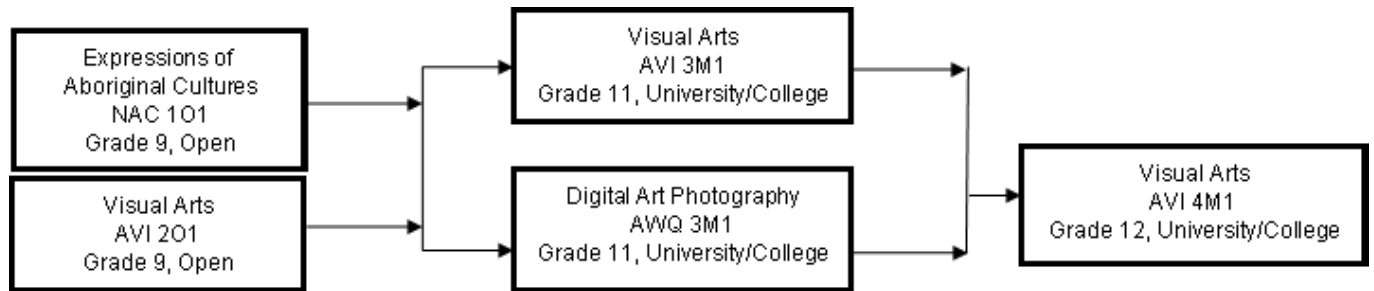

EXPRESSIONS OF ABORIGINAL CULTURES

Grade 9 - Open

NAC 101

This course will explore a variety of contemporary and traditional First Nations, Métis, and Inuit art forms such as new media, storytelling, installation and performance art. Students will examine the interrelationships between Aboriginal art forms and individual and cultural identities and values. They will create art works to express their own ideas and understanding of Aboriginal identity, relationships, and sovereignty by using a range of media, processes, techniques, and styles.

Prerequisite: None

Fee: \$20.00

VISUAL ARTS

Grade 10 - Open

AVI 201

This course enables students to develop their skills in producing and presenting art by introducing them to new ideas, materials, and processes for artistic exploration and experimentation. Students will apply the elements and principles of design when exploring the creative process. Students will use the critical analysis process to reflect on and interpret art within a personal, contemporary, and historical context.

Prerequisite: None

Fee: \$20.00

VISUAL ARTS

Grade 11 - University/College

AVI 3M1

This course enables students to further develop their knowledge and skills in visual arts. Students will use the creative process to explore a wide range of themes through studio work that may include drawing, painting, sculpting, and printmaking, as well as the creation of collage, multimedia works, and works using emergent technologies. Students will use the critical analysis process when evaluating their own work and the work of others. The course may be delivered as a comprehensive program or through a program focused on a particular art form (e.g. photography, video, computer graphics, information design).

Prerequisite: AVI 101 or AVI 201

Fee \$40.00

VISUAL ARTS - DIGITAL ART PHOTOGRAPHY

Grade 11 - University/College Preparation

AWQ 3M1

This course follows the curriculum expectations of AVI 3M (see above) with a focus on digital art photography. Students will learn photographic principles, the fundamentals of camera technique, digital darkroom, colour theory, digital editing and printing. This course is activity and client-based and will revolve around critical thinking and problem solving in digital photography. Students will have access to school cameras but a digital SLR camera is recommended.

Prerequisite: AVI 101 or AVI 201

Fee: \$40.00

VISUAL ARTS

Grade 12 - University/College Preparation

AVI 4M1

This course focuses on enabling students to refine their use of the creative process when creating and presenting two- and three-dimensional art works using a variety of traditional and emerging media and technologies. Students will use the critical analysis process to deconstruct art works and explore connections between art and society. The studio program enables students to explore a range of materials, processes, and techniques that can be applied in their own art production. Students will also make connections between various works of art in personal, contemporary, historical, and cultural contexts.

Prerequisite: AVI 3M1 or AWI 3M1 or AWQ3M1

Fee: \$40.00

BUSINESS STUDIES

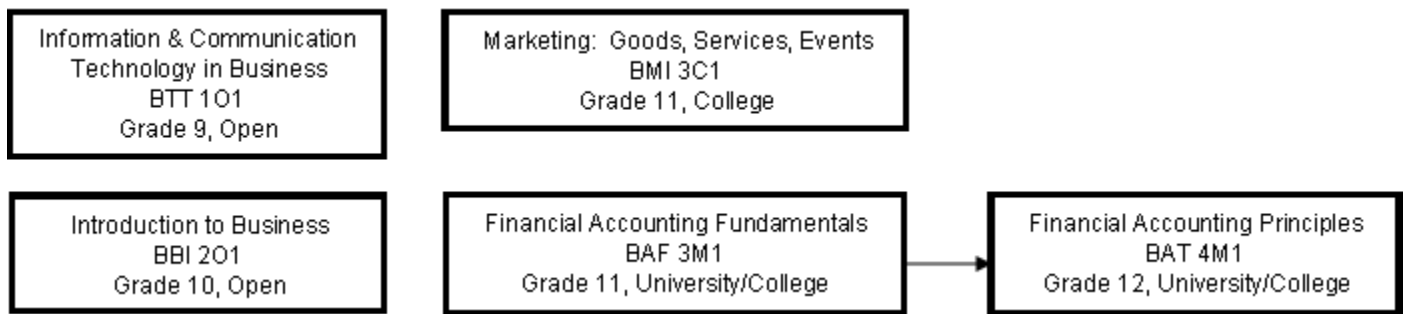

INFORMATION AND COMMUNICATION TECHNOLOGY IN BUSINESS

Grade 9 - Open

BTT101

This course introduces students to information and communication technology in a business environment and builds a foundation of digital literacy skills necessary for success in a technologically driven society. Students will develop word processing, spreadsheet, database, desktop publishing, presentation software, and website design skills. Throughout the course, there is an emphasis on digital literacy, effective electronic research and communication skills, and current issues related to the impact of information and communication technology. At St. Paul BTT101 will focus on providing hands on experience learning the computer software that students may need in order to complete projects required at secondary school and beyond. Programs may include Word, Excel, Powerpoint, Desktop Publisher and others.

Prerequisite: None

INTRODUCTION TO BUSINESS

Grade 10 - Open

BBI 201

This course introduces students to the world of business. Students will develop an understanding of the functions of business, including accounting, marketing, information and communication technology, human resources, and production, and of the importance of ethics and social responsibility. This course builds a foundation for further studies in business and helps students develop the business knowledge and skills they will need in their everyday lives.

Prerequisite: None

MARKETING: GOODS, SERVICES, EVENTS

Grade 11 - College Preparation

BMI 3C1

This course introduces the fundamental concepts of product marketing, which includes the marketing of goods, services, and events. Students will examine how trends, issues, global economic changes, and information technology influence consumer buying habits. Students will engage in marketing research, develop marketing strategies, and produce a marketing plan for a product of their choice.

Prerequisite: None

FINANCIAL ACCOUNTING FUNDAMENTALS

Grade 11 - University/College Preparation

BAF 3M1

This course introduces students to the fundamental principles and procedures of accounting. Students will develop financial analysis and decision-making skills that will assist them in future studies and/or career opportunities in business. Students will acquire an understanding of accounting for a service and a merchandising business, computerized accounting, financial analysis, and ethics and current issues in accounting.

Prerequisite: None

Fee: \$25.00

FINANCIAL ACCOUNTING - PRINCIPLES

Grade 12 - University/College Preparation

BAT 4M1

This course introduces students to advanced accounting principles that will prepare them for postsecondary studies in business. Students will learn about financial statements for various forms of business ownership and how those statements are interpreted in making business decisions. This course expands students' knowledge of sources of financing, further develops accounting methods for assets, and introduces accounting for partnerships and corporations.

Prerequisite: BAF 3M1

This course is offered every other year. It will be offered for the 2017-18 school year.

CANADIAN AND WORLD STUDIES

GEOGRAPHY

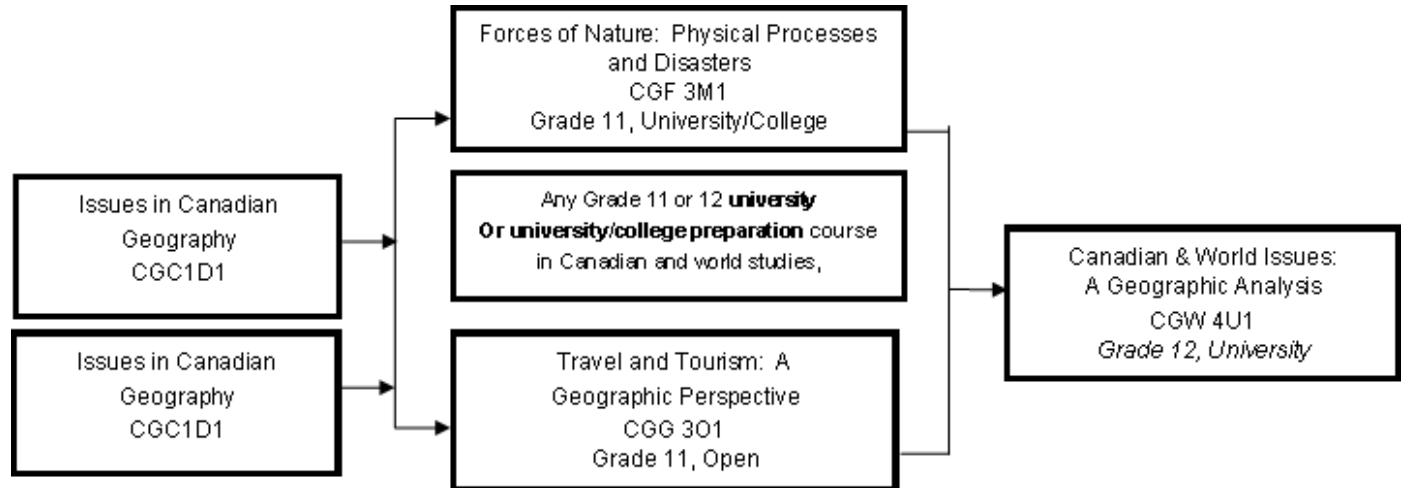

ISSUES IN CANADIAN GEOGRAPHY

Grade 9 - Academic

CGC 1D1

This course examines interrelationships within and between Canada's natural and human systems and how these systems interconnect with those in other parts of the world. Students will explore environmental, economic, and social geographic issues relating to topics such as transportation options, energy choices, and urban development. Students will apply the concepts of geographic thinking and the geographic inquiry process, including spatial technologies, to investigate various geographic issues and to develop possible approaches for making Canada a more sustainable place to live.

ISSUES IN CANADIAN GEOGRAPHY

Grade 9 - Applied

CGC 1P1

This course focuses on current geographic issues that affect Canadians. Students will draw on their personal and everyday experiences as they explore issues relating to food and water supplies, competing land uses, interactions with the natural environment, and other topics relevant to sustainable living in Canada. They will also develop an awareness that issues that affect their lives in Canada are interconnected with issues in other parts of the world. Throughout the course, students will use the concepts of geographic thinking, the geographic inquiry process, and spatial technologies to guide and support their investigations.

FORCES OF NATURE: PHYSICAL PROCESSES AND DISASTERS

Grade 11 - University/College

CGF 3M1

In this course, students will explore physical processes related to the earth's water, land, and air. They will investigate how these processes shape the planet's natural characteristics and affect human systems, how they are involved in the creation of natural disasters, and how they influence the impacts of human disasters. Throughout the course, students will apply the concepts of geographic thinking and the geographic inquiry process and use spatial technologies to analyse these processes, make predictions related to natural disasters, and assess ways of responding to them.

Prerequisite: CGC 1D1 or CGC 1P1 or CGC 1DF

TRAVEL AND TOURISM: A GEOGRAPHIC PERSPECTIVE

Grade 11 - Open

CGG 3O1

This course focuses on issues related to travel and tourism within and between various regions of the world. Students will investigate unique environmental, sociocultural, economic, and political characteristics of selected world regions. They will explore travel patterns and trends as well as tensions related to tourism, and will predict future tourism destinations. Students will apply the concepts of geographic thinking and the geographic inquiry process, including spatial technologies, to investigate the impact of the travel industry on natural environments and human communities.

Prerequisite: CGC 1D or CGC 1P1 or CGC 1DF

WORLD ISSUES: A GEOGRAPHIC ANALYSIS

Grade 12 - University Preparation

CGW 4U1

In this course, students will address the challenge of creating a more sustainable and equitable world. They will explore issues involving a wide range of topics, including economic disparities, threats to the environment, globalization, human rights, and quality of life, and analyse government policies, international agreements, and individual responsibilities relating to them. Students will apply the concepts of geographic thinking and the geographic inquiry process, including the use of spatial technologies, to investigate these complex issues and their impact on natural and human communities around the world.

Prerequisite: Any U or M course in Canadian and world studies, English, or social sciences and humanities.

HISTORY

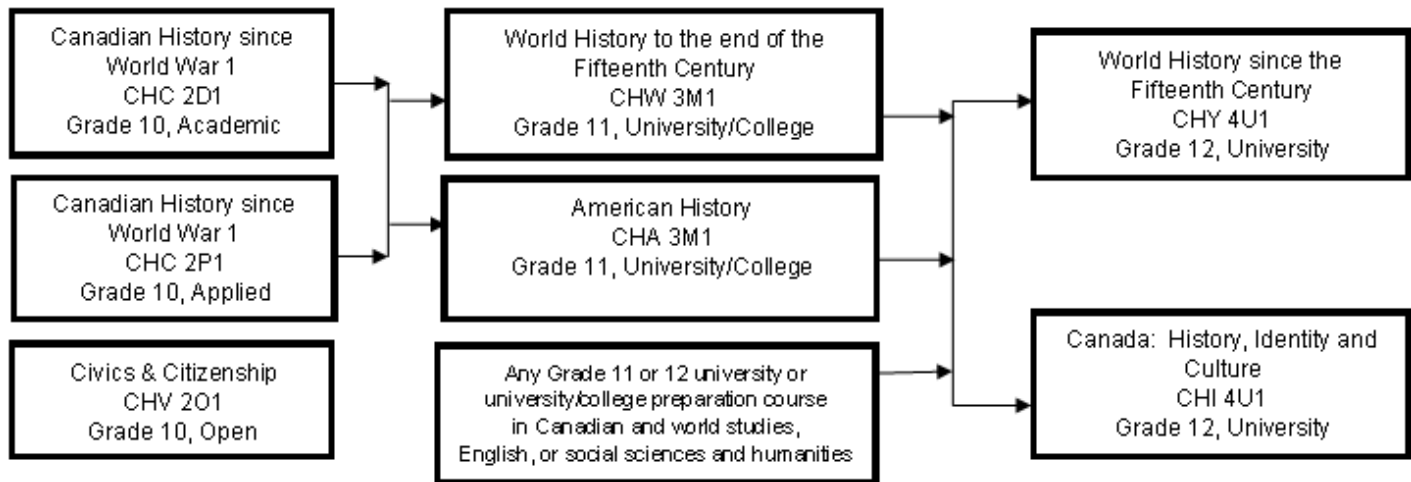

CANADIAN HISTORY SINCE WORLD WAR I

Grade 10 - Academic

CHC 2D1

This course explores social, economic, and political developments and events and their impact on the lives of different groups in Canada since 1914. Students will examine the role of conflict and cooperation in Canadian society, Canada's evolving role within the global community, and the impact of various individuals, organizations, and events on Canadian identity, citizenship, and heritage. They will develop their ability to apply the concepts of historical thinking and the historical inquiry process, including the interpretation and analysis of evidence, when investigating key issues and events in Canadian history since 1914.

CANADIAN HISTORY SINCE WORLD WAR I

Grade 10 - Applied

CHC 2P1

This course focuses on the social context of historical developments and events and how they have affected the lives of people in Canada since 1914. Students will explore interactions between various communities in Canada as well as contributions of individuals and groups to Canadian heritage and identity. Students will develop their ability to apply the concepts of historical thinking and the historical inquiry process, including the interpretation and analysis of evidence, when investigating the continuing relevance of historical developments and how they have helped shape communities in present-day Canada.

CIVICS AND CITIZENSHIP

Grade 10 - Open (.5 credit)

CHV 201

This course explores rights and responsibilities associated with being an active citizen in a democratic society. Students will explore issues of civic importance such as healthy schools, community planning, environmental responsibility, and the influence of social media, while developing their understanding of the role of civic engagement and of political processes in the local, national, and/or global community. Students will apply the concepts of political thinking and the political inquiry process to investigate, and express informed opinions about a range of political issues and developments that are both of significance in today's world and of personal interest to them.

WORLD HISTORY TO THE END OF THE 15TH CENTURY

Grade 11 - University/College Preparation

CHW 3M1

This course explores the history of various societies and civilizations around the world, from earliest times to around 1500 CE. Students will investigate a range of factors that contributed to the rise, success, and decline of various ancient and pre-modern societies throughout the world and will examine life in and the cultural and political legacy of these societies. Students will extend their ability to apply the concepts of historical thinking and the historical inquiry process, including the interpretation and analysis of evidence, when investigating social, political, and economic structures and historical forces at work in various societies and in different historical eras.

Prerequisite: CHC 2D1 or CHC 2P1 or CHC 2DF

This course is offered every other year. It will be offered for the 2016-2017 school year.

AMERICAN HISTORY

Grade 11 - University Preparation

CHA 3U1

This course explores key aspects of the social, economic, and political development of the United States from precontact to the present. Students will examine the contributions of groups and individuals to the country's evolution and will explore the historical context of key issues, trends, and events that have had an impact on the United States, its identity and culture, and its role in the global community. Students will extend their ability to apply the concepts of historical thinking and the historical inquiry process, including the interpretation and analysis of evidence, when investigating various forces that helped shape American history..

Prerequisite: CHC 2D1 or CHC 2P1 or CHC 2DF

This course is offered every other year. It will be offered for the 2017-18 school year.

WORLD HISTORY SINCE THE FIFTEENTH CENTURY

Grade 12 - University Preparation

CHY 4U1

This course traces major developments and events in world history since approximately 1450. Students will explore social, economic, and political changes, the historical roots of contemporary issues, and the role of conflict and cooperation in global interrelationships. They will extend their ability to apply the concepts of historical thinking and the historical inquiry process, including the interpretation and analysis of evidence, as they investigate key issues and ideas and assess societal progress or decline in world history.

Prerequisite: Any U or M course in Canadian and world studies, English, or social sciences and humanities.

This course is offered every other year. It will be offered for the 2017-2018 school year.

CANADA: HISTORY, IDENTITY & CULTURE

Grade 12 - University Preparation

CHI 4U1

This course traces the history of Canada, with a focus on the evolution of our national identity and culture as well as the identity and culture of various groups that make up Canada. Students will explore various developments and events, both national and international, from pre-contact to the present, and will examine various communities in Canada and how they have contributed to the development of identity and heritage in Canada. Students will investigate the development of culture and identify, including national identity, in Canada and how and why they have changed throughout the country's history. They will extend their ability to apply the concepts of historical thinking and the historical inquiry process, including the interpretation and analysis of evidence, as they investigate the people, events, and forces that have shaped Canada.

Prerequisite: Any U or M course in Canadian and world studies, English, or social sciences and humanities.

This course is offered every other year. It will be offered for the 2016-17 school year

ECONOMICS, LAW & POLITICS

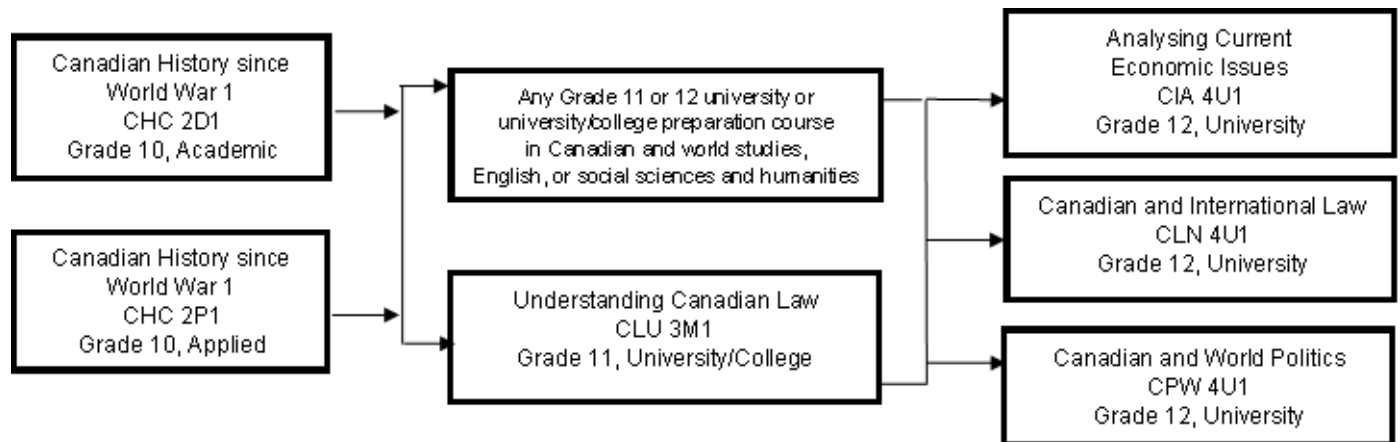

UNDERSTANDING CANADIAN LAW

Grade 11 - University/College Preparation

CLU 3M1

This course explores Canadian law, with a focus on legal issues that are relevant to the lives of people in Canada. Students will gain an understanding of laws relating to rights and freedoms in Canada, our legal system, and family, contract, employment, tort, and criminal law. Students will develop legal reasoning skills and will apply the concepts of legal thinking and the legal studies inquiry process when investigating a range of legal issues and formulating and communicating informed opinions about them.

Prerequisite: CHC 2D1 or CHC 2P1 or CHC 2DF

ANALYSING CURRENT ECONOMIC ISSUES

Grade 12 - University Preparation

CIA 4U1

This course examines current Canadian and international economic issues, developments, policies, and practices from diverse perspectives. Students will explore the decisions that individuals and institutions, including governments, make in response to economic issues such as globalization, trade agreements, economic inequalities, regulation, and public spending. Students will apply the concepts of economic thinking and the economic inquiry process, as well as economic models and theories, to investigate, and develop informed opinions about, economic trade-offs, growth, and sustainability and related economic issues.

Prerequisite: Any U or M course in Canadian and world studies, English, or social sciences and humanities.

CANADIAN AND INTERNATIONAL LAW

Grade - 12 - University Preparation

CLN 4U1

This course explores a range of contemporary legal issues and how they are addressed in both Canadian and international law. Students will develop an understanding of the principles of Canadian and international law and of issues related to human rights and freedoms, conflict resolution, and criminal, environmental, and workplace law, both in Canada and internationally. Students will apply the concept of legal thinking and the legal studies inquiry process, and will develop legal reasoning skills, when investigating these and other issues in both Canadian and international contexts.

Prerequisite: Any U or M course in Canadian and world studies, English, or social sciences and humanities.

CANADIAN AND INTERNATIONAL POLITICS

Grade 12 - University Preparation

CPW 4U1

This course explores various perspectives on issues in Canadian and world politics. Students will explore political decision making and ways in which individuals, stakeholder groups, and various institutions, including government, multinational corporations, and non-governmental organizations, respond to and work to address domestic and international issues. Students will apply the concepts of political thinking and the political inquiry process to investigate issues, events, and developments of national and international political importance, and to develop and communicate informed opinions about them.

Prerequisite: Any U or M course in Canadian and world studies, English, or social sciences and humanities

ENGLISH

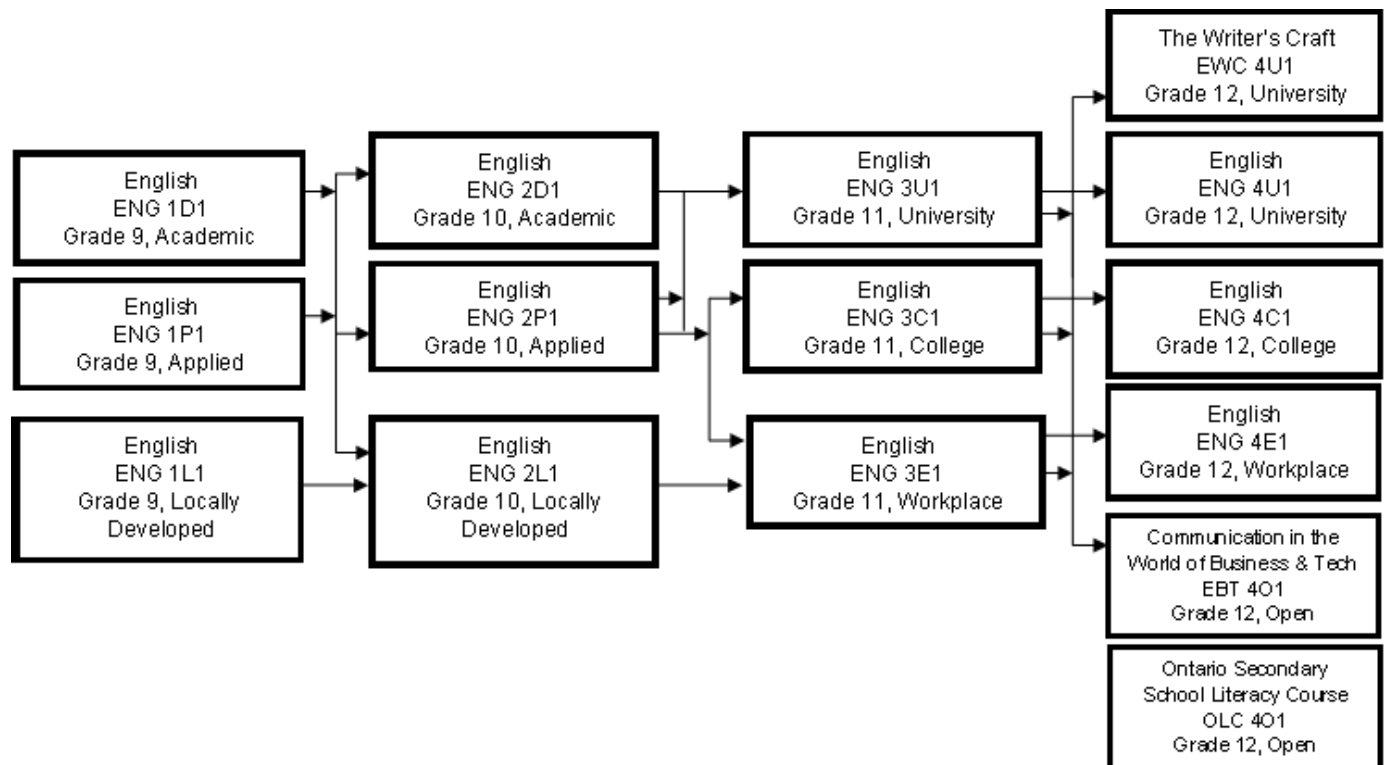

COMPULSORY COURSES

ENGLISH

Grade 9 - Academic

ENG 1D1

This course is designed to develop the oral communication, reading, writing, and media literacy skills that students need for success in their secondary school academic programs and in their daily lives. Students will analyse literacy texts from contemporary and historical periods, interpret informational and graph texts, and create oral, written, and media texts in a variety of forms. An important focus will be on the use of strategies that contribute to effective communication. This course is intended to prepare students for the Grade 10 academic English course, which leads to university or college preparation courses in Grades 11 and 12.

ENGLISH**Grade 9 - Applied****ENG 1P1**

This course is designed to develop the key oral communications, reading, writing, and media literacy skills students need for success in secondary school and daily life. Students will read, interpret, and create a variety of informational, literacy, and graphic texts. An important focus will be on identifying and using appropriate strategies and processes to improve students' comprehension of texts and to help them communicate clearly and effectively. The course is intended to prepare students for the Grade 10 applied English course, which leads to college or workplace preparation courses. In Grade 11 and 12.

ESSENTIALS OF ENGLISH**Grade 9 - Locally Developed****ENG 1L1**

This course provides foundational literacy and communication skills to prepare students for success in their daily lives, in the workplace, and in the English Grade 11 Workplace Preparation course. The course is organized by strands that develop listening and talking skills, reading and viewing skills, and writing skills. In all strands, the focus is on developing foundational literacy skills and in using language clearly and accurately in a variety of authentic contexts. Students develop strategies and put into practice the processes involved in talking, listening, reading, viewing, writing, and thinking, and reflect regularly upon their growth in these areas.

ENGLISH**Grade 10 - Academic****ENG 2D1**

This course is designed to extend the range of oral communication, reading, writing, and media literacy skills that students need for success in their secondary school academic programs and in their daily lives. Students will analyse literacy texts from contemporary and historical periods, interpret and evaluate informational and graphic texts, and create oral, written, and media texts in a variety of forms. An important focus will be on the selective use of strategies that contribute to effective communications. This course is intended to prepare students for the compulsory Grade 11 university or college preparation course.

Prerequisite: Grade 9 English, Academic and Applied

ENGLISH

Grade 10 - Applied

ENG 2P1

This course is designed to extend the range of oral communication, reading, writing, and media literacy skills that students need for success in secondary school and daily life. Students will study and create a variety of informational, literacy, and graphic texts. An important focus will be on the consolidation of strategies and processes that help students to interpret texts and communicate clearly and effectively. This course is intended to prepare students for the compulsory Grade 11 college or workplace preparation course.

Prerequisite: Grade 9 English, Academic or Applied

ESSENTIALS OF ENGLISH

Grade 10 - Locally Developed

ENG 2L1

In this course, students focus on extending their literacy and communication skills to prepare for success in their daily lives, in the workplace, in the English Grade 11 Workplace Preparation course, or in the English: Contemporary Aboriginal Voices, Grade 11 Workplace Preparation course. The course is organized by strands that extend listening and talking skills, reading and viewing skills, and writing skills. In all strands, the focus is on refining foundational literacy skills and in using language clearly and accurately in a variety of authentic contexts. Students build on their strategies and engage in the processes involved in talking, listening, reading, viewing, writing, and thinking, and reflect regularly upon their growth in these areas.

Prerequisite: Grade 9 English, Academic, Applied or Locally Developed

ENGLISH

Grade 11 - University Preparation

ENG 3U1

This course emphasizes the development of literacy, communication, and critical and creative thinking skills necessary for success in academic and daily life. Students will analyse challenging literary texts from various periods, countries, and cultures, as well as a range of informational and graphic texts, and create oral, written, and media texts in a variety of forms. An important focus will be on using language with precision and clarity and incorporating stylistic devices appropriately and effectively. This course is intended to prepare students for the compulsory Grade 12 university or college preparation course.

Prerequisite: Grade 10 English Academic

ENGLISH**Grade 11 - College Preparation****ENG 3C1**

This course emphasizes the development of literacy, communication, and critical and creative thinking skills necessary for success in academic and daily life. Students will study the content, form, and style of a variety of informational and graphic texts, as well as literary texts from Canada and other countries, and create oral, written, and media texts in a variety of forms for practical and academic purposes. An important focus will be on using language with precision and clarity. The course is intended to prepare students for the compulsory Grade 12 college preparation course.

Prerequisite: Grade 10 English, Applied

ENGLISH**Grade 11 - Workplace Preparation****ENG 3E1**

This course emphasizes the development of literacy, communication, and critical and creative thinking skills necessary for success in the workplace and in daily life. Students will study the content, form, and style of a variety of contemporary informational, graphic, and literary texts; and create oral, written, and media texts in a variety of forms for practical purposes. An important focus will be on using language clearly and accurately in a variety of formal and informal contexts. This course is intended to prepare students for the compulsory Grade 12 workplace preparation course.

Prerequisite: Grade 10 English, Locally Developed

ENGLISH**Grade 12 - University Preparation****ENG 4U1**

This course emphasizes the consolidation of the literacy, communication, and critical and creative thinking skills necessary for success in academic, and daily life. Students will analyse a range of challenging literary texts from various periods, countries, and cultures; interpret and evaluate informational and graphic texts; and create oral, written, and media texts in a variety of forms. An important focus will be on using academic language coherently and confidently, selecting the reading strategies best suited to particular texts, and particular purposes for reading, and developing greater control in writing. The course is intended to prepare students for university, college, or the workplace.. Prerequisite: Grade 11 English, University Preparation

ENGLISH

Grade 12 - College Preparation

ENG 4C1

This course emphasizes the consolidation of literacy, communication, and critical and creative thinking skills necessary for success in academic and daily life. Students will analyse a variety of informational and graphic texts, as well as literary texts from various countries and cultures, and create oral, written, and media texts in a variety of forms for practical and academic purposes. An important focus will be on using language with precision and clarity and developing greater control in writing. This course is intended to prepare students for college or the workplace.

Prerequisite: Grade 11 English, College Preparation

ENGLISH

Grade 12 - Workplace Preparation

ENG 4E1

This course emphasizes the consolidation of literacy, communication, and critical and creative thinking skills necessary for success in the workplace and in daily life. Students will analyse informational, graphic, and literary texts and create oral, written, and media texts in a variety of forms for workplace-related and practical purposes. An important focus will be on using language accurately and organizing ideas and information coherently. The course is intended to prepare students for the workplace and active citizenship.

Prerequisite: Grade 11 English, Workplace Preparation

OPTIONAL COURSES

LITERACY SKILLS: READING AND WRITING

GRADE 10 - Open

ELS201

This course is designed to help students strengthen essential reading and writing skills, providing them with the extra literacy support they need in order to graduate. Students will read informational, graphic, and literary texts, with a focus on locating information, identifying main ideas and supporting details, building vocabulary, and consolidating skills in the application of key comprehension strategies. This course will also help students develop core learning strategies.

Students do not select this course at course selection time; students who meet the eligibility criteria for this course will be contacted by their Guidance Counselor.

MEDIA STUDIES

Grade 11 - Open

EMS 301

This course emphasizes knowledge and skills that will enable students to understand media communication in the twenty-first century and to use media effectively and responsibly. Through analyzing the forms and messages of a variety of media works and audience responses to them, and through creating their own media works, students will develop critical thinking skills, aesthetic and ethical judgement, and skills in viewing, representing, listening, speaking, reading and writing.

Prerequisite: Grade 10 English, Academic or Applied

THE WRITER'S CRAFT

Grade 12 - University Preparation

EWC 4U1

This course emphasizes knowledge and skills related to the craft of writing. Students will analyse models of effective writing; use a workshop approach to produce a range of works; identify and use techniques required for specialized forms of writing; and identify effective ways to improve the quality of their writing. They will also complete a major paper as part of a creative or analytical independent study project and investigate opportunities for publication and for writing careers.

Prerequisite: Grade 11 English, University Preparation

COMMUNICATION IN THE WORLD OF BUSINESS AND TECHNOLOGY

Grade 12 - Open

EBT 4O1

This course emphasizes practical writing and communication skills that are needed in the world of business and technology. Students will analyze the characteristics of effective models of business and technical communications; gather information to write reports, business letters, memos, manuals, instructions, and brochures; and integrate graphics and text, using technology appropriately for formatting and special effects. They will also make a number of oral and visual presentations.

Prerequisite: Grade 11 English, University, College, or Workplace Preparation

ONTARIO SECONDARY SCHOOL LITERACY COURSE

Grade 12 - Open

OLC 401

This course is designed to help students acquire and demonstrate the cross-curricular literacy skills that are evaluated by the Ontario Secondary School Literacy Test (OSSLT). Students who complete the course successfully will meet the provincial literacy requirement for graduation. Students will read a variety of informational, narrative, and graphic texts and will produce a variety of forms of writing, including summaries, information paragraphs, opinion pieces, and news reports. Students will also maintain and manage a portfolio containing a record of their reading experiences and samples of their writing. The credit earned for successful completion of this course may be used to meet either the Grade 12 English compulsory credit requirement or the Group 1 additional compulsory credit requirement, or may be used as an elective credit.

Students do not select this course at course selection time; students who meet the eligibility criteria for this course will be contacted by their Guidance Counselor.

FRENCH

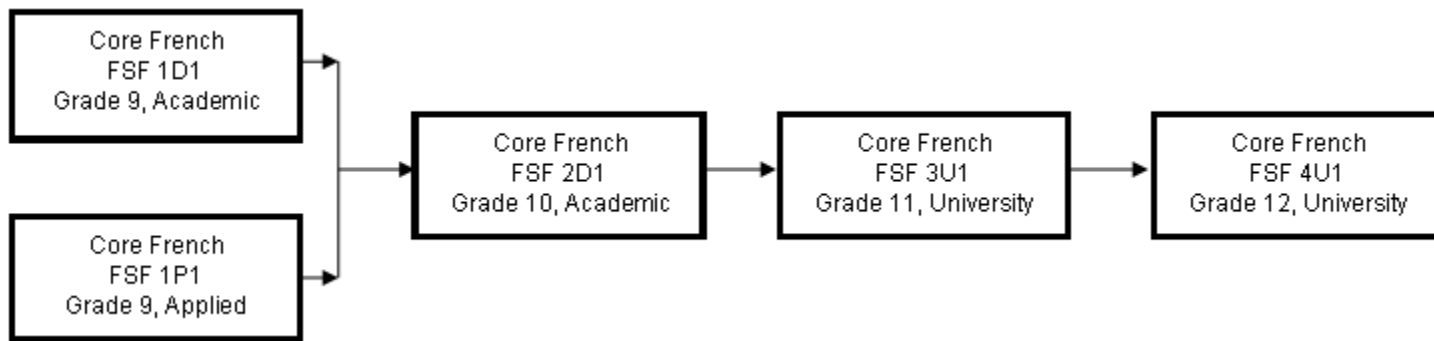

CORE FRENCH

Grade 9 - Academic

FSF 1D1

This course provides opportunities for students to communicate and interact in French with increasing independence, with a focus on familiar topics related to their daily lives. Students will continue to develop language knowledge and skills by using language-learning strategies introduced in the elementary Core French program, and will apply creative and critical thinking skills in various ways. They will also enhance their understanding and appreciation of diverse French-speaking communities, and will develop the skills necessary to become life-long language learners.

Prerequisite: Minimum of 600 hours of elementary Core French instruction, or equivalent

CORE FRENCH

Grade 9 - Applied

FSF 1P1

This course provides opportunities for students to communicate and interact in French in structured situations on everyday topics and to apply their knowledge of French in everyday situations. Students will continue to develop language knowledge and skills introduced in the elementary Core French program, through practical applications and concrete examples, and will use creative and critical thinking skills in various ways. They will also enhance their understanding and appreciation of diverse French-speaking communities, and will develop the skills necessary to become life-long language learners.

Prerequisite: Minimum of 600 hours of elementary Core French instruction, or equivalent

CORE FRENCH
Grade 10 - Academic
FSF 2D1

This course provides opportunities for students to communicate in French about personally relevant, familiar, and academic topics in real-life situations with increasing independence. Students will exchange information, ideas and opinions with others in guided and increasingly spontaneous spoken interactions. Students will continue to develop their language knowledge and skills through the selective use of strategies that contribute to effective communication. They will also increase their understanding and appreciation of diverse French-speaking communities, and will continue to develop the skills necessary to become life-long language learners.

Prerequisite: FSF 1D1 or FSF 1P1

CORE FRENCH
Grade 11 - University Preparation
FSF 3U1

This course offers students extended opportunities to speak and interact in French in real-life situations. Students will continue to develop their communication skills, making connections to previous experiences and using newly acquired language knowledge and skills. They will also continue to increase their understanding and appreciation of diverse French-speaking communities and to develop the skills necessary for life-long language learning.

Prerequisite: FSF 2D1

CORE FRENCH
Grade 12 - University Preparation
FSF 4U1

This course provides extensive opportunities for students to speak and interact in French independently. Students will apply language-learning strategies in a wide variety of real-life situations, and will continue to develop their creative and critical thinking skills through responding to and interacting with a variety of oral and written texts. Students will also continue to enrich their understanding and appreciation of diverse French-speaking communities and to develop the skills necessary for life-long language learning.

Prerequisite: FSF 3U1

EXTENDED FRENCH

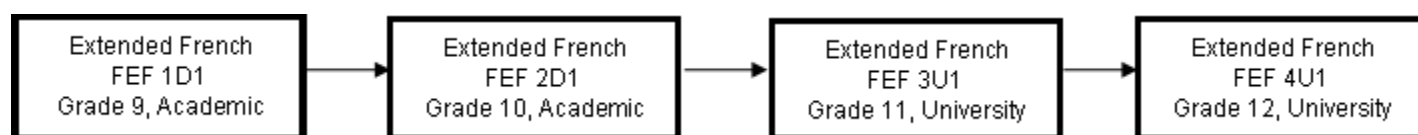

EXTENDED FRENCH

Grade 9 - Academic

FEF 1D1

This course provides opportunities for students to speak and interact in French in a variety of real-life and personally relevant contexts. Students will continue to use language-learning strategies introduced in the elementary Extended French program. They will develop their creative and critical thinking skills, through independently responding to and interacting with a variety of oral and written texts, and will continue to enhance their understanding and appreciation of diverse French-speaking communities. They will also develop the skills necessary to become life-long language learners.

Prerequisite: Minimum of 1260 hours of instruction in elementary Extended French, or equivalent

EXTENDED FRENCH

Grade 10 - Academic

FEF 2D1

This course provides extensive opportunities for students to use their communication skills in French and to apply language-learning strategies. Students will respond to and interact with French oral and written texts in a variety of real-life contexts, using their creative and critical thinking skills to explore and evaluate information and ideas in the texts. Students will increase their knowledge of the language through the study of French-Canadian authors. They will also continue to increase their understanding appreciation of French-speaking communities and to develop the skills necessary to become life-long language learners.

Prerequisite: FEF 1D1

EXTENDED FRENCH

Grade 11 - University Preparation

FEF 3U1

This course provides opportunities for students to communicate about concrete and abstract topics in various situations. Students will consolidate language-learning strategies and apply them in a variety of real-life contexts in order to enhance and refine their communication skills, and will continue to develop creative and critical thinking skills. Students will develop their knowledge of the language through the study of contemporary and well-known French European authors. They will continue to deepen their understanding and appreciation of diverse French-speaking communities, and develop the skills necessary to become life-long language learners.

Prerequisite: FEF 2D1

EXTENDED FRENCH

Grade 12 - University Preparation

FEF 4U1

This course further emphasizes the consolidation of communication skills required to interact in French for various purposes about concrete and abstract topics. Students will independently apply language-learning strategies in a variety of real-life and personally relevant contexts, and will broaden their creative and critical thinking skills through responding to and analysing oral and written texts. Students will increase their knowledge of the language through the study of Canadian and international French literature. They will also continue to enrich their understanding and appreciation of diverse French-speaking communities and to develop the skills necessary to become life-long language learners.

Prerequisite: FEF 3U1

OTHER COURSES IN FRENCH

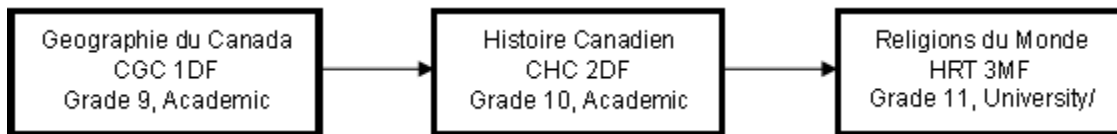

GEOGRAPHIE DU CANADA

Grade 9 - Academic - Extended

CGC1DF

This course uses a variety of frameworks, including ecozones and principles of physical, human, and economic geography, to explore the distinct and evolving character of Canada's geography. Students will investigate the interconnections between the environment and human activities in Canadian ecozones in order to understand Canada's diversity and role in the world.

Suggested co-requisite: FEF 1D1

This course is offered every other year. It will be offered for the 2017-18 school year.

HISTOIRE CANADIEN

Grade 10 - Academic - Extended

CHC 2DF

This course explores Canadian participation in global events and traces our development as a country through changes in population, economy, and technology. Students will analyze the elements that constitute Canadian identity, learn the stories of both individuals and communities, and study the evolution of political and social structures. Students will learn about differing interpretations of the past, and will come to understand the importance in historical studies of chronology and cause-and-effect relationships. They will also learn to develop and support a thesis, conduct research and analysis, and effectively communicate the results of their inquiries.

Prerequisite: None

Suggested co-requisite: FEF 2D1

This course is offered every other year. It will be offered for the 2016-2017 school year.

RELIGIONS DU MONDE

Grade 11 - University/College Preparation - Extended

HRT 3MF

This course enables students to discover what others believe and how they live, and to appreciate their own unique heritage. Students will learn about the teachings of a variety of religions, the connections between religion and the development of civilizations, the place and function of religion in human experience, and the influence of a broad range of religions on contemporary society. This course also introduces students to skills used in researching and investigating world religions.

Prerequisite: None

Suggested co-requisite: FEF 3U1

This course is offered every other year. It will be offered for the 2017-2018 school year.

GUIDANCE AND CAREER EDUCATION



LEARNING STRATEGIES: SKILLS FOR SUCCESS IN SECONDARY SCHOOL

Grade 9 - Open

GLS 101

This course focuses on learning strategies to help students become better, more independent learners. Students will learn how to develop and apply literacy and numeracy skills, personal management skills, and interpersonal and teamwork skills to improve their learning and achievement in school, the workplace, and the community. The course helps students build confidence and motivation to pursue opportunities for success in secondary school and beyond. Students do not select this course at course selection time; students who meet the eligibility criteria for this course will be contacted by their Guidance Counselor.

CAREER STUDIES

Grade 10 - Open (0.5 credit)

GLC 201

This course teaches students how to develop and achieve personal goals for future learning, work, and community involvement. Students will assess their interests, skills, and characteristics and investigate current economic and workplace trends, work opportunities, and ways to search for work. The course explores postsecondary learning and career options, prepares students for managing work and life transitions, and helps students focus on their goals through the development of a career plan.

Prerequisite: None

LEADERSHIP AND PEER SUPPORT

Grade 11 - Open

GPP 301

This course prepares students to act in leadership and peer support roles. They will design and implement a plan for contributing to their school and/or community; develop skills in communication, interpersonal relations, teamwork, and conflict management; and apply those skills in leadership and/or peer support roles – for example, as a student council member or a peer tutor. Students will examine group dynamics and learn the value of diversity within groups and communities. At St. Paul students in this course work as peer tutors in grade 9 or 10 classes.

Prerequisite: None

LEADING, LEARNING AND RELATING: PEER MEDIATION, COUNSELING AND PEER TUTORING

Grade 12 - University Preparation

IDC 4U1

This course explores human relations, communication and behaviour; learning strategies and barriers; and personality and leadership styles that affect individuals in educational, social, and business settings. Students in this course will be trained in conflict resolution, restorative justice, peer counseling and peer mediation, and may practise these skills as peer helpers to support students through the initiatives of the Student Success program. Students will apply the principles and processes of inquiry and research to effectively use a range of print, electronic, and mass media resources; to analyse historical innovations and exemplary research; and to investigate real-life situations and career opportunities in interdisciplinary endeavours. They will also assess their own cognitive and affective strategies, apply general skills in both familiar and new contexts, create innovative products, and communicate new knowledge.

Prerequisite: Any U or M course in Canadian and world studies, English, or social sciences and humanities.

Recommended: GPP 30

LEADING, LEARNING AND RELATING: PEER MEDIATION, COUNSELING AND PEER TUTORING

Grade 12 - Open

IDC 401

Students in this course will be trained in conflict resolution, restorative justice, peer counseling and peer mediation, and may practise these skills as peer helpers to support students through the initiatives of the Student Success program. This course emphasizes the development of practical skills and knowledge to solve problems, make decisions, create personal meaning, and present findings beyond the scope of a single subject or discipline. Through individual and collaborative inquiry and research into contemporary issues, real-life situations, and careers, students will apply the principles and skills derived from the complementary subjects and disciplines studied, evaluate the reliability of information, and examine how information technology can be used safely, effectively, and legally. They will also learn how to select strategies to define problems, research alternative solutions, assess their thinking in reaching decisions, and adapt to change as they acquire new knowledge

Prerequisite: None

Recommended: GPP 30

COOPERATIVE EDUCATION

Students can earn 2 or 4 Co-op credits per semester; in most cases, students choose a 2-credit Co-op which takes place in either the morning or the afternoon. Co-op credits can be linked to any subject area. In the past students have been placed in a wide variety of settings, including legal, accounting, and architecture firms; municipal and provincial offices, police departments, and libraries; day care centres, schools, and hospitals; dental and veterinary offices; hotels, restaurants, and bakeries; fitness clubs and physiotherapy clinics; automotive, construction and manufacturing companies; and a variety of retail environments.

To apply for Co-op, students write CO-OP on the course selection sheet (in two or four spaces). Students must also complete a separate application form available from the Co-op department. Students who apply undergo a counselling and interviewing process conducted by Co-operative education teachers, guidance counsellors, and administrators. Prior to their placement in the workplace, students attend an in-school work orientation program. Once placed, a Personal Placement Learning Plan is designed for each student. Periodically, all Co-op students participate in Integration Days organized to reinforce the relationship between “on-the-job” practical experience and classroom theory.

Liability insurance and Workplace Safety & Insurance Board coverage is in place for all Co-op students.

Students accepted into the Co-operative Education program who pursue a work placement in an apprenticeship area are also automatically OYAP students. Their Co-op placement may lead to an apprenticeship, if this is the destination a student chooses to pursue.

To be eligible for OYAP, students must

- be in grade 11 or 12, be at least 16 years of age, and be enrolled full-time in school.
- have earned at least 16 credits.
- agree to follow an education plan designed specifically for the apprenticeship destination in order to complete the requirements for the apprenticeship training and graduation.
- demonstrate competencies in certain subject areas.
- undergo a formal application process, which includes the regular Co-op process.

These programs allow secondary school students to complete part one of the theoretical components needed for all apprenticeship training. To be successful, the student will be required to meet the training requirements of the Ministry of Training, Colleges and Universities.

The student will complete secondary school Co-operative education credits in conjunction with the college or approved Training Centre program.

Students interested in these programs should see the Co-op Department for more details.

APPRENTICESHIP AND DUAL CREDIT PROGRAMS OFFERED IN 2016-17 SCHOOL YEAR

	LOYALIST COLLEGE		
College-Delivered Dual Credits	Semester	Apprenticeship College-Delivered Level 1 Accreditation	Semester
Child & Youth Worker	1 & 2	Automotive Service Technician	2
Principles of Learning	1 & 2	Child Development Practitioner	2
Roots to Success	1 & 2	Cook	2
Trades Sampler	May		

DUAL CREDIT PROGRAMS

The Dual Credit Program provides secondary students with the opportunity to earn up to four, non-compulsory dual credits by participating in apprenticeship training and post-secondary courses that count toward both their secondary school diploma and their post-secondary diploma or apprenticeship certification. The course codes for dual credit classes differ from the course codes delivered at the home school.

SPECIALIST HIGH SKILLS MAJOR

At St. Paul, students have the option of completing a Specialist High Skills Major in Transportation, Health and Wellness or Hospitality and Tourism. Students pursuing the Transportation Specialist High Skills Major program will take 4 Transportation major credits, 2 Co-op credits, and 3 compulsory credits. Students taking the Health and Wellness Specialist High Skills Major will complete 4 Hairstyling and Aesthetics major credits as well as 2 credits of Co-op and 3 compulsory credits. Students pursuing the Hospitality and Tourism Specialist High Skills Major program will take 4 Hospitality and Tourism credits, 2 Co-op credits and 3 compulsory credits. Students pursuing the Non-Profit SHSM program will take 4 specialized credits, 2 Co-op credits and 3 compulsory credits. In all programs, students will receive industry specific certifications and “reach ahead” experiences connected with the student’s postsecondary pathway. Students interested in this program should contact the Guidance Department.

HEALTH AND PHYSICAL EDUCATION

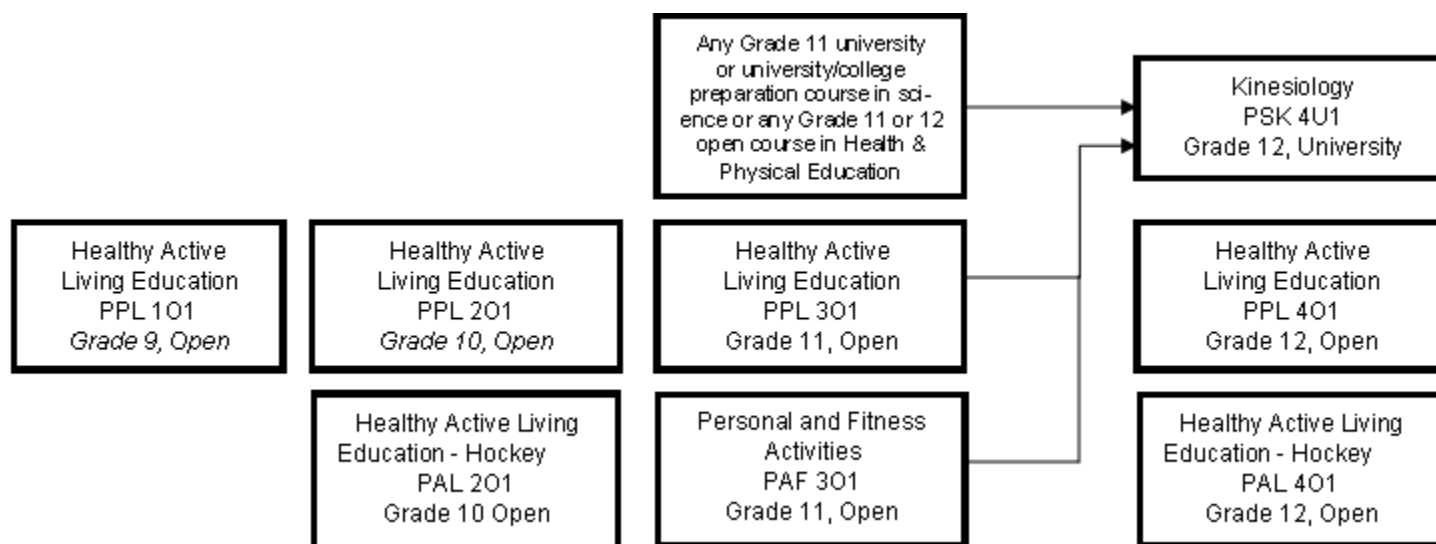

Healthy Active Living Education

Grade 9 - Open

PPL101

This course equips students with the knowledge and skills they need to make healthy choices now and lead healthy, active lives in the future. Through participation in a wide range of physical activities, students develop knowledge and skills related to movement competence and personal fitness that provide a foundation for active living. Students also acquire an understanding of the factors and skills that contribute to healthy development and learn how their own well-being is affected by, and affects, the world around them. Students build their sense of self, learn to interact positively with others, and develop their ability to think critically and creatively.

Prerequisite: None

Healthy Active Living Education

Grade 10 - Open

PPL201

This course enables students to further develop the knowledge and skills they need to make healthy choices now and lead healthy, active lives in the future. Through participation in a wide range of physical activities, students develop knowledge and skills related to movement competence and personal fitness that provide a foundation for active living. Students also acquire an understanding of the factors and skills that contribute to healthy development and learn how their own well-being is affected by, and affects, the world around them. Students build their sense of self, learn to interact positively with others, and develop their ability to think critically and creatively.

Prerequisite: None

PERSONAL AND FITNESS ACTIVITIES

Grade 11 - Open

PAF 301

This course enables students to further develop the knowledge and skills they need to make healthy choices now and lead healthy, active lives in the future. Through participation in a wide range of physical activities and exposure to a broader range of activity settings, students enhance their movement competence, personal fitness, and confidence. Students also acquire an understanding of the factors and skills that contribute to healthy development and learn how their own well-being is affected by, and affects, the world around them. Students build their sense of self, learn to interact positively with others, and develop their ability to think critically and creatively

This course will focus on constantly varied functional movements executed at high intensity across broad time. The use of weights and gymnastics movements will be incorporated through all training.

Prerequisite: None

Healthy Active Living Education

Grade 11 - Open

PPL 301

This course enables students to further develop the knowledge and skills they need to make healthy choices now and lead healthy, active lives in the future. Through participation in a wide range of physical activities and exposure to a broader range of activity settings, students enhance their movement competence, personal fitness, and confidence. Students also acquire an understanding of the factors and skills that contribute to healthy development and learn how their own well-being is affected by, and affects, the world around them. Students build their sense of self, learn to interact positively with others, and develop their ability to think critically and creatively.

Prerequisite: None

Healthy Active Living Education

Grade 12 - Open

PPL 401

This course enables students to further develop the knowledge and skills they need to make healthy choices. It places special emphasis on how students can maintain the habits of healthy, active living throughout their lives as they make the transition to adulthood and independent living. Through participation in a wide range of physical activities in a variety of settings, students can enhance their movement competence, personal fitness, and confidence. Students also acquire an understanding of the factors and skills that contribute to healthy development and learn how their own well-being is affected by, and affects, the world around them. Students build their sense of self, learn to interact positively with others, and develop their ability to think critically and creatively.

Prerequisite: None

Fee: \$70.00 is applied to the course for out of school activities.

PERSONAL AND FITNESS ACTIVITIES

Grade 12 - Open

PAF 401

This course follows the curriculum expectations of PPL401 (see above) but is geared toward regular participation in a variety of enjoyable fitness activities that promote life-long healthy active living. Student learning will include the application of movement principles to refine their skills, participation in a variety of fitness activities with a focus on weight training and cardio exercises that enhance personal competence, health, and examination of issues related to healthy living.

This course will focus on constantly varied functional movements executed at high intensity across broad time. The use of weights and gymnastics movements will be incorporated through all training.

Prerequisite: None

PERSONAL AND FITNESS ACTIVITIES - ST. PAUL HOCKEY SKILLS ACADEMY

Grade 10/12 - Open

PAL 201/401

This course covers the same curriculum expectations as the PPL201 and PPL401. St. Paul Hockey Skills Academy allows students in grades nine through twelve to take part in hockey drills, scrimmages and activities. This course will focus on hockey skill fundamentals. Skating, edging, hand position during shooting and passing, and theory of game play.

Prerequisite: None

Fee: \$180.00 is applied to the course for ice time and uniform.

Introductory Kinesiology

Grade 12, University Preparation

PSK 4U1

This course focuses on the study of human movement and of systems, factors, and principles involved in human development. Students will learn about the effects of physical activity on health and performance, the evolution of physical activity and sports, and the factors that influence an individual's participation in physical activity. The course prepares students for university programs in physical education, kinesiology, recreation, and sports administration.

Prerequisite: Any Grade 11 U or M course in science, or any Grade 11 or 12 open course in health and physical education.

Fee: \$20.00

HUMANITIES AND SOCIAL SCIENCES

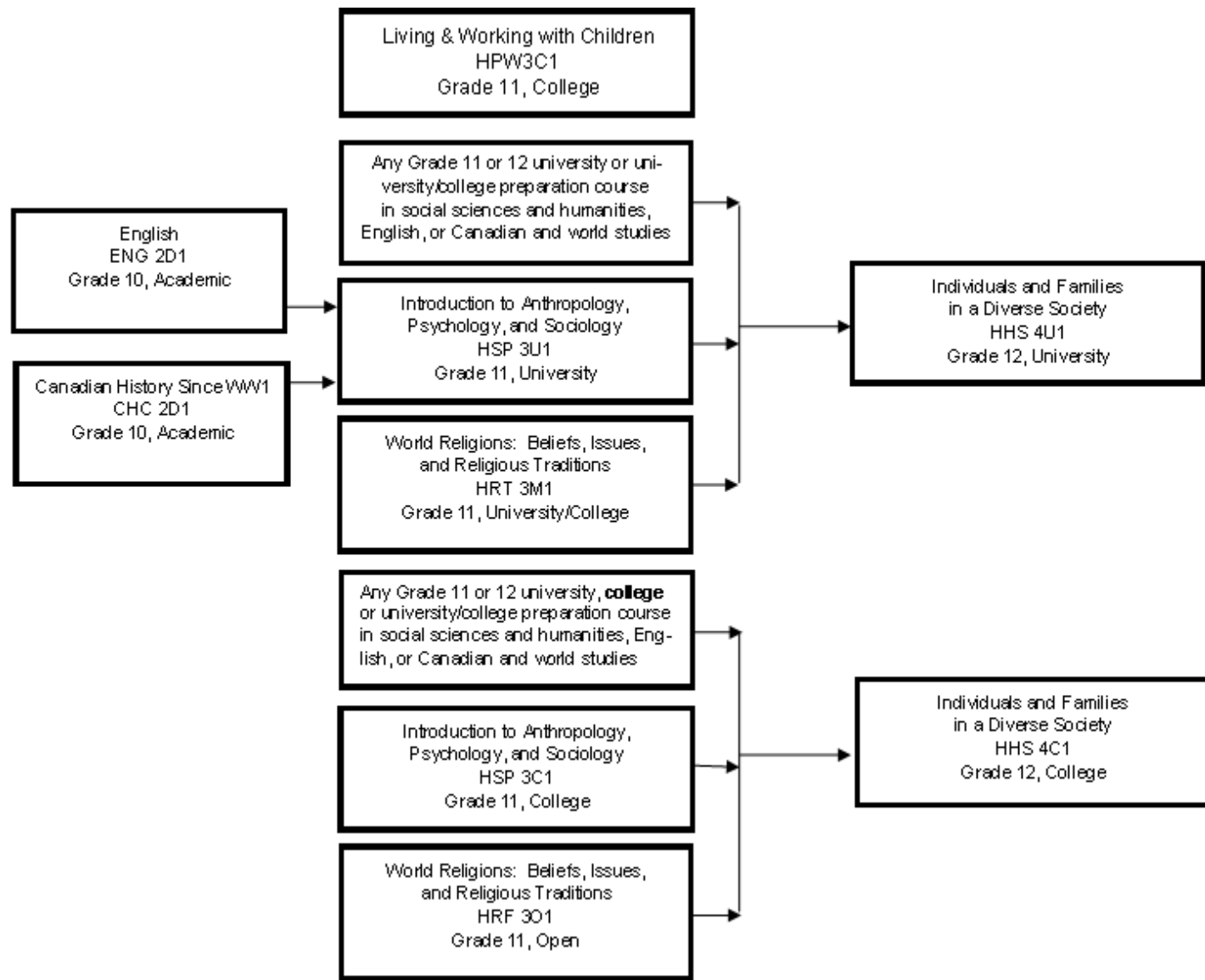

Working With Infants and Young Children Grade 11, College Preparation HPW3C1

This course prepares students for occupations involving children from birth to six years of age. Students will study theories about child behaviour and development, and will have opportunities for research and observation and for practical experiences with young children. Students will become familiar with occupational opportunities and requirements related to working with infants and young children. They will also have opportunities to develop research and critical-thinking skills as they investigate and evaluate current research about early childhood education.

Prerequisite: None

INTRODUCTION TO ANTHROPOLOGY, PSYCHOLOGY, AND SOCIOLOGY

Grade 11 - University/College Preparation

HSP 3U1

This course provides students with opportunities to think critically about theories, questions, and issues related to anthropology, psychology, and sociology. Students will develop an understanding of the approaches and research methods used by social scientists. They will be given opportunities to explore theories from a variety of perspectives, to conduct social science, and to become familiar with current thinking on a range of issues within the three disciplines.

Prerequisite: ENG2D1 or CHC2D1

INTRODUCTION TO ANTHROPOLOGY, PSYCHOLOGY, AND SOCIOLOGY

Grade 11 - University/College Preparation

HSP 3C1

This course introduces students to theories, questions, and issues related to anthropology, psychology, and sociology. Students learn about approaches and research methods used by social scientists. They will be given opportunities to apply theories from a variety of perspectives, to conduct social science research, and to become familiar with current issues within the three disciplines.

Prerequisite: None

FAMILIES IN CANADA

Grade 12 - University/College Preparation

HHS 4U1

This course enables students to draw on sociological, psychological, and anthropological theories and research to analyse the development of individuals, intimate relationships, and family and parent-child relationships. Students will focus on issues and challenges facing individuals and families in Canada's diverse society. They will develop analytical tools that enable them to assess various factors affecting families and to consider policies and practices intended to support families in Canada. They will develop the investigative skills required to conduct and communicate the results of research on individuals, intimate relationships, and parent-child relationships.

Prerequisite: Any U or M course in Canadian and world studies, English, or social sciences and humanities.

FAMILIES IN CANADA**Grade 12 - University/College Preparation****HHS 4C1**

This course enables students to develop an understanding of social science theories as they apply to individual development, the development of intimate relationships, and family and parent-child relationships. Students will explore a range of issues relating to the development of individuals and families in contemporary Canadian society as well as in other cultures and historical periods. They will develop the investigative skills required to conduct research on individuals, intimate relationships, and parent-child roles and relationships in Canada.

Prerequisite: Any U, C or M course in Canadian and world studies, English, or social sciences and humanities.

The following Humanities courses are also offered as part of the Religion program:

WORLD RELIGIONS: BELIEFS, ISSUES, AND RELIGIOUS TRADITIONS**Grade 11 - University/College or Open****HRT 3M1, HRF 3O1**

Course descriptions and prerequisites can be found in the Religion section of the course offerings.

MATHEMATICS

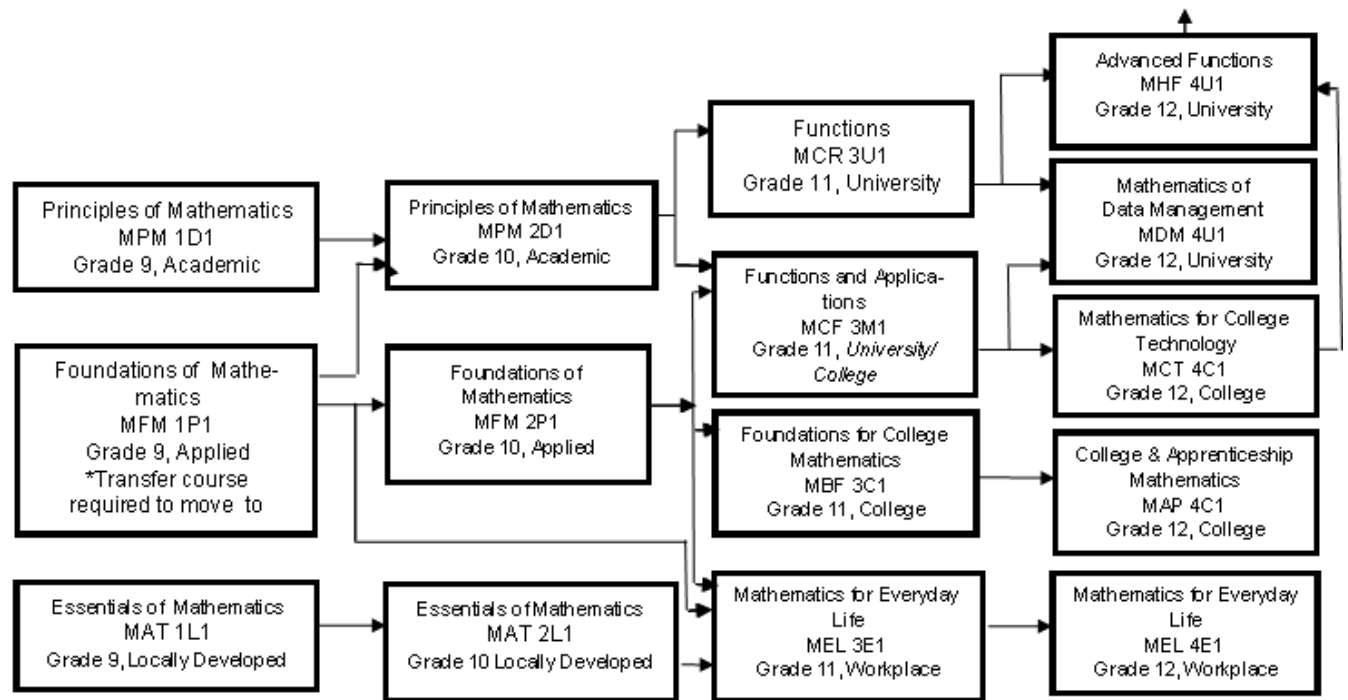

PRINCIPLES OF MATHEMATICS

Grade 9 - Academic

MPM 1D1

This course enables students to develop understanding of mathematical concepts related to algebra, analytic geometry, and measurement and geometry through investigation, the effective use of technology, and abstract reasoning. Students will investigate relationships, which they will then generalize as equations of lines, and will determine the connections between different representations of a relationship. They will also explore relationships that emerge from the measurement of three-dimensional objects and two-dimensional shapes. Students will reason mathematically and communicate their thinking as they solve multistep problems.

FOUNDATIONS OF MATHEMATICS

Grade 9 - Applied

MFM 1P1

This course enables students to develop understanding of mathematical concepts related to introductory algebra, proportional reasoning, and measurement and geometry through investigation, the effective use of technology, and hands-on activities. Students will investigate real-life examples to develop various representations of linear relationships, and will determine the connections between the representations. They will also explore certain relationships that emerge from the measurement of three-dimensional objects and two-dimensional shapes. Students will consolidate their mathematical skills as they solve problems and communicate their thinking.

ESSENTIALS OF MATHEMATICS

Grade 9 - Locally Developed

MAT 1L1

This course emphasizes further development of mathematical knowledge and skills to prepare students for success in their everyday lives, in the workplace, in the Grade 10 locally developed course, and in the Mathematics Grade 11 and Grade 12 Workplace Preparation courses. Three strands related to money sense, measurement, and proportional reasoning organize the course. In all strands, the focus is on developing and consolidating key foundational mathematical concepts and skills by solving authentic, everyday problems. Students have opportunities to further develop their mathematical literacy and problem-solving skills and to continue developing their skills in reading, writing, and oral language through relevant and practical math activities.

PRINCIPLES OF MATHEMATICS

Grade 10 - Academic

MPM 2D1

This course enables students to broaden their understanding of relationships and extend their problem-solving and algebraic skills through investigations, the effective use of technology, and abstract reasoning. Students will explore quadratic relationships and their applications; solve and apply linear systems; verify properties of geometric figures using analytic geometry; and investigate the trigonometry of right and acute triangles. Students will reason mathematically as they solve multistep problems and communicate their thinking.

Prerequisite: MPM 1D1

FOUNDATIONS OF MATHEMATICS

Grade 10 - Applied

MFM 2P1

This course enables students to consolidate their understanding of linear relations and extend their problem-solving and algebraic skills through investigation, the effective use of technology, and hands-on activities. Students will develop and graph equations in analytic geometry; solve and apply linear systems, using real-life examples; and explore triangles, the trigonometry of right-angled triangles, and the measurement of three-dimensional objects. Students will consolidate their mathematical skills as they solve problems and communicate their thinking.

Prerequisite: MPM 1D1 or MFM 1P1

ESSENTIALS OF MATHEMATICS

Grade 10 - Locally Developed

MAT 2L1

This course emphasizes the extension of mathematical knowledge and skills to prepare students for success in their everyday lives, in the workplace, and in the Mathematics Grade 11 and Grade 12 Workplace Preparation courses. The course is organized by three strands related to money sense, measurement, and proportional reasoning. In all strands, the focus is on strengthening and extending key foundational mathematical concepts and skills by solving authentic, everyday problems. Students have opportunities to extend their mathematical literacy and problem-solving skills and to continue developing their skills in reading, writing, and oral language through relevant and practical math activities.

Prerequisite: MPM 1D1 or MFM 1P1 or MAT 1L1

FUNCTIONS

Grade 11 - University Preparation

MCR 3U1

This course introduces the mathematical concept of the function by extending students' experiences with linear and quadratic relations. Students will investigate properties of discrete and continuous functions, including trigonometric and exponential functions; represent functions numerically, algebraically, and graphically; solve problems involving applications of functions; and develop facility in simplifying polynomial and rational expressions. Students will reason mathematically and communicate their thinking as they solve multi-step problems.

Prerequisite: MPM 2D1

FUNCTIONS AND APPLICATIONS

Grade 11 - University/College Preparation

MCF 3M1

This course introduces basic features of the function by extending students' experiences with quadratic relations. It focuses on quadratic, trigonometric, and exponential functions and their use in modelling real-world situations. Students will represent functions numerically, graphically, and algebraically; simplify expressions; solve equations; and solve problems relating to financial and trigonometric applications. Students will reason mathematically and communicate their thinking as they solve multi-step problems.

Prerequisite: MPM 2D1 or MFM 2P1

FOUNDATIONS FOR COLLEGE MATHEMATICS

Grade 11 - College Preparation

MBF 3C1

This course enables students to broaden their understanding of mathematics as a problem-solving tool in the real world. Students will extend their understanding of quadratic relations, as well as of measurement and geometry; investigate situations involving exponential growth; solve problems involving compound interest; solve financial problems connected with vehicle ownership; and develop their ability to reason by collecting, analysing, and evaluating data involving one and two variables. Students will consolidate their mathematical skills as they solve problems and communicate their thinking.

Prerequisite: MFM 2P1 or MPM 2D1

MATHEMATICS FOR WORK AND EVERYDAY LIFE

Grade 11 - Workplace Preparation

MEL 3E1

This course enables students to broaden their understanding of mathematics as it is applied in the workplace and daily life. Students will solve problems associated with earning money, paying taxes, and making purchases; apply calculations of simple and compound interest in saving, investing, and borrowing; and calculate the costs of transportation and travel in a variety of situations. Students will consolidate their mathematical skills as they solve problems and communicate their thinking.

Prerequisite: MPM 2D1 or MFM 2P1 or MAT 2L1

ADVANCED FUNCTIONS

Grade 12, University Preparation

MHF4U1

This course extends students' experience with functions. Students will investigate the properties of polynomial, rational, logarithmic, and trigonometric functions; broaden their understanding of rates of change; and develop facility in applying these concepts and skills. Students will also refine their use of the mathematical processes necessary for success in senior mathematics. This course is intended both for students who plan to study mathematics in university and for those wishing to consolidate their understanding of mathematics before proceeding to any one of a variety of university programs.

Prerequisite: MCR 3U1 or MCT 4C1

CALCULUS AND VECTORS

Grade 12 - University Preparation

MCV4U1

This course builds on students' previous experience with functions and their developing understanding of rates of change. Students will solve problems involving geometric and algebraic representations of vectors, and representations of lines and planes in three-dimensional space; broaden their understanding of rates of change to include the derivatives of polynomial, rational, exponential, and sinusoidal functions; and apply these concepts and skills to the modelling of real-world relationships. Students will also refine their use of the mathematical processes necessary for success in senior mathematics. This course is intended for students who plan to study mathematics in university and who may choose to pursue careers in fields such as physics and engineering.

Note: The Advanced Functions can be taken concurrently with or can precede Calculus and Vectors.

Prerequisite or Co-requisite: MHF 4U1

MATHEMATICS OF DATA MANAGEMENT

Grade 12 - University Preparation

MDM 4U1

This course broadens students' understanding of mathematics as it relates to managing data. Students will apply methods for organizing large amounts of information; solve problems involving probability and statistics; and carry out a culminating project that integrates statistical concepts and skills. Students will also refine their use of the mathematical processes necessary for success in senior mathematics. Students planning to enter university programs in business, the social sciences, and the humanities will find this course of particular interest.

Prerequisite: MCR 3U1 or MCF 3M1

MATHEMATICS FOR COLLEGE TECHNOLOGY

Grade 12 - College Preparation

MCT 4C1

This course enables students to extend their knowledge of functions. Students will investigate and apply properties of polynomial, exponential, and trigonometric functions; continue to represent functions numerically, graphically, and algebraically; develop facility in simplifying expressions and solving equations; and solve problems that address applications of algebra, trigonometry, vectors, and geometry. Students will reason mathematically and communicate their thinking as they solve multi-step problems. This course prepares students for a variety of college technology programs.

Prerequisite: MCF 3M1 or MCR 3U1

FOUNDATIONS FOR COLLEGE MATHEMATICS

Grade 12 - College Preparation

MAP 4C1

This course enables students to broaden their understanding of real-world applications of mathematics. Students will analyse data using statistical methods; solve problems involving applications of geometry and trigonometry; solve financial problems connected with annuities, budgets, and renting or owning accommodation; simplify expressions; and solve equations. Students will reason mathematically and communicate their thinking as they solve multi-step problems. This course prepares students for college programs in areas such as business, health sciences, and human services, and for certain skilled trades.

Prerequisite: MBF 3C1 or MCF 3M1 or MCR 3U1

MATHEMATICS FOR WORK AND EVERYDAY LIFE

Grade 12 - Workplace Preparation

MEL 4E1

This course enables students to broaden their understanding of mathematics as it is applied in the workplace and daily life. Students will investigate questions involving the use of statistics; apply the concept of probability to solve problems involving familiar situations; investigate accommodation costs, create household budgets, and prepare a personal income tax return; use proportional reasoning; estimate and measure; and apply geometric concepts to create designs. Students will consolidate their mathematical skills as they solve problems and communicate their thinking.

Prerequisite: MEL 3E1

SCIENCE

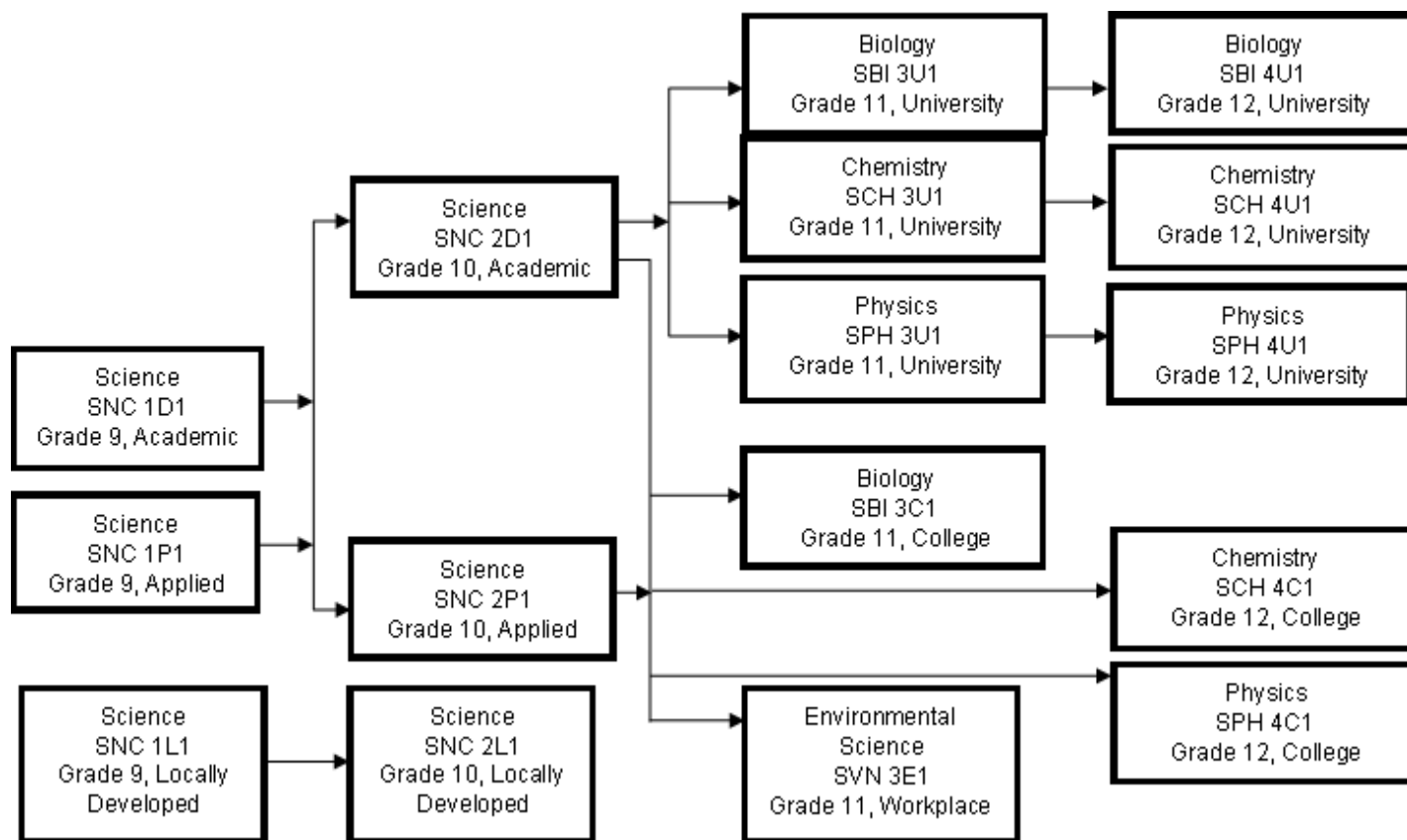

SCIENCE

Grade 9 - Academic

SNC 1D1

This course enables students to develop their understanding of basic concepts in biology, chemistry, earth and space science, and physics, and to relate science to technology, society, and the environment. Throughout the course, students will develop their skills in the processes of scientific investigation. Students will acquire an understanding of scientific theories and conduct investigations related to sustainable ecosystems; atomic and molecular structures and the properties of elements and compounds; the study of the universe and its properties and components; and the principles of electricity.

SCIENCE**Grade 9 - Applied****SNC 1P1**

This course enables students to develop their understanding of basic concepts in biology, chemistry, earth and space science, and physics, and to apply their knowledge of science to everyday situations. They are also given opportunities to develop practical skills related to scientific investigation. Students will plan and conduct investigations into practical problems and issues related to the impact of human activity on ecosystems; the structure and properties of elements and compounds; space exploration and the components of the universe; and static and current electricity.

SCIENCE**Grade 9 -Locally Developed****SNC 1L1**

This course emphasizes reinforcing and strengthening science-related knowledge and skills, including scientific inquiry, critical thinking, and the relationship between science, society, and the environment, to prepare students for success in everyday life, in the workplace, and in the Grade 10 Locally Developed Science course. Students explore a range of topics, including science in daily life, properties of common materials, life-sustaining processes in simple and complex organisms, and electrical circuits. Students have the opportunity to extend mathematical and scientific process skills and to continue developing their skills in reading, writing, and oral language through relevant and practical science activities.

SCIENCE**Grade 10 - Academic****SNC 2D1**

This course enables students to enhance their understanding of concepts in biology, chemistry, earth and space science, and physics, and of the interrelationships between science, technology, society, and the environment. Students are also given opportunities to further develop their scientific investigation skills. Students will plan and conduct investigations and develop their understanding of scientific theories related to the connections between cells and systems in animals and plants; chemical reactions, with a particular focus on acid-base reactions; forces that affect climate and climate change; and the interaction of light and matter.

Prerequisite: SNC 1D1 or SNC 1P1

SCIENCE

Grade 10 - Applied

SNC 2P1

This course enables students to develop a deeper understanding of concepts in biology, chemistry, earth and space science, and physics, and to apply their knowledge of science in real-world situations. Students are given opportunities to develop further practical skills in scientific investigation. Students will plan and conduct investigations into everyday problems and issues related to human cells and body systems; chemical reactions; factors affecting climate change; and the interaction of light and matter.

Prerequisite: SNC 1D1 or SNC 1P1

SCIENCE

Grade 10 - Locally Developed

SNC 2L1

This course emphasizes reinforcing and strengthening science-related knowledge and skills, including scientific inquiry, critical thinking, and the environmental impact of science and technology, to prepare students for success in everyday life, and in the workplace and in the Science Grade 11 Workplace Preparation course. Students explore a range of topics including science in the media, interactions of common materials, interdependence of organisms in communities, and using electrical energy. Students have the opportunity to extend mathematical and scientific process skills and to continue developing their skills in reading, writing, and oral language through relevant and practical science activities.

Prerequisite: SNC 1D1 or SNC 1P1 or SNC 1L1

ENVIRONMENTAL SCIENCE

Grade 11 - Workplace Preparation

SVN 3E1

This course provides students with the fundamental knowledge of and skills relating to environmental science that will help them succeed in work and life after secondary school. Students will explore a range of topics, including the impact of human activities on the environment; human health and the environment; energy conservation; resource science and management; and safety and environmental responsibility in the workplace. Emphasis is placed on relevant, practical applications and current topics in environmental science, with attention to the refinement of students' literacy and mathematical literacy skills as well as the development of their scientific and environmental literacy.

Prerequisite: Any grade 9 or 10 science

BIOLOGY

Grade 11 - University Preparation

SBI 3U1

This course furthers students' understanding of the processes that occur in biological systems. Students will study theory and conduct investigations in the areas of biodiversity; evolution; genetic processes; the structure and function of animals; and the anatomy, growth, and function of plants. The course focuses on the theoretical aspects of the topics under study, and helps students refine skills related to scientific investigation.

Prerequisite: SNC 2D1

BIOLOGY

Grade 11 - College Preparation

SBI 3C1

This course focuses on the processes that occur in biological systems. Students will learn concepts and theories as they conduct investigations in the areas of cellular biology, microbiology, genetics, the anatomy of mammals and the structure of plants and their role in the natural environment. Emphasis will be placed on the practical application of concepts, and on the skills needed for further study in various branches of the life sciences and related fields.

Prerequisite: SNC 2D1 or SNC 2P1

CHEMISTRY

Grade 11 - University Preparation

SCH 3U1

This course enables students to deepen their understanding of chemistry through the study of the properties of chemicals and chemical bonds; chemical reactions and quantitative relationships in those reactions; solutions and solubility; and atmospheric chemistry and the behaviour of gases. Students will further develop their analytical skills and investigate the qualitative and quantitative properties of matter, as well as the impact of some common chemical reactions on society and the environment.

Prerequisite: SNC 2D1

PHYSICS

Grade 11 - University Preparation

SPH 3U1

This course develops students' understanding of the basic concepts of physics. Students will explore kinematics, with an emphasis on linear motion; different kinds of forces; energy transformations; the properties of mechanical waves and sound; and electricity and magnetism. They will enhance their scientific investigation skills as they test laws of physics. In addition, they will analyse the interrelationships between physics and technology, and consider the impact of technological applications of physics on society and the environment.

Prerequisite: SNC 2D1

BIOLOGY

Grade 12 - University Preparation

SBI 4U1

This course provides students with the opportunity for in-depth study of the concepts and processes that occur in biological systems. Students will study theory and conduct investigations in the areas of biochemistry, metabolic processes, molecular genetics, homeostasis, and population dynamics. Emphasis will be placed on the achievement of detailed knowledge and the refinement of skills needed for further study in various branches of the life sciences and related fields.

Prerequisite: SBI 3U1

CHEMISTRY

Grade 12 - University Preparation

SCH 4U1

This course enables students to deepen their understanding of chemistry through the study of organic chemistry, the structure and properties of matter, energy changes and rates of reaction, equilibrium in chemical systems, and electrochemistry. Students will further develop their problem-solving and investigation skills as they investigate chemical processes, and will refine their ability to communicate scientific information. Emphasis will be placed on the importance of chemistry in everyday life and on evaluating the impact of chemical technology on the environment.

Prerequisite: SCH 3U1

CHEMISTRY

Grade 12 - College Preparation

SCH 4C1

This course enables students to develop an understanding of chemistry through the study of matter and qualitative analysis, organic chemistry, electrochemistry, chemical calculations, and chemistry as it relates to the quality of the environment. Students will use a variety of laboratory techniques, develop skills in data collection and scientific analysis, and communicate scientific information using appropriate terminology. Emphasis will be placed on the role of chemistry in daily life and the effects of technological applications and processes on society and the environment.

Prerequisite: SNC 2D1 or SNC 2P1

PHYSICS

Grade 12 - University Preparation

SPH 4U1

This course enables students to deepen their understanding physics concepts and theories. Students will continue their exploration of energy transformations and the forces that affect motion, and will investigate electrical, gravitational, and magnetic fields and electromagnetic radiation. Students will also explore the wave nature of light, quantum mechanics, and special relativity. They will further develop their scientific investigation skills, learning, for example, how to analyse, qualitatively and quantitatively, data relating to a variety of physics concepts and principles. Students will also consider the impact of technological applications of physics on society and the environment.

Prerequisite: SPH 3U1

PHYSICS

Grade 12 - College Preparation

SPH 4C1

This course develops students' understanding of the basic concepts of physics. Students will explore these concepts with respect to motion; mechanical, electrical, electromagnetic, energy transformation, hydraulic, and pneumatic systems; and the operation of commonly used tools and machines. They will develop their scientific investigation skills as they test laws of physics and solve both assigned problems and those emerging from their investigations. Students will also consider the impact of technological applications of physics on society and the environment.

Prerequisite: SNC 2D1 or SNC 2P1

TECHNOLOGICAL EDUCATION

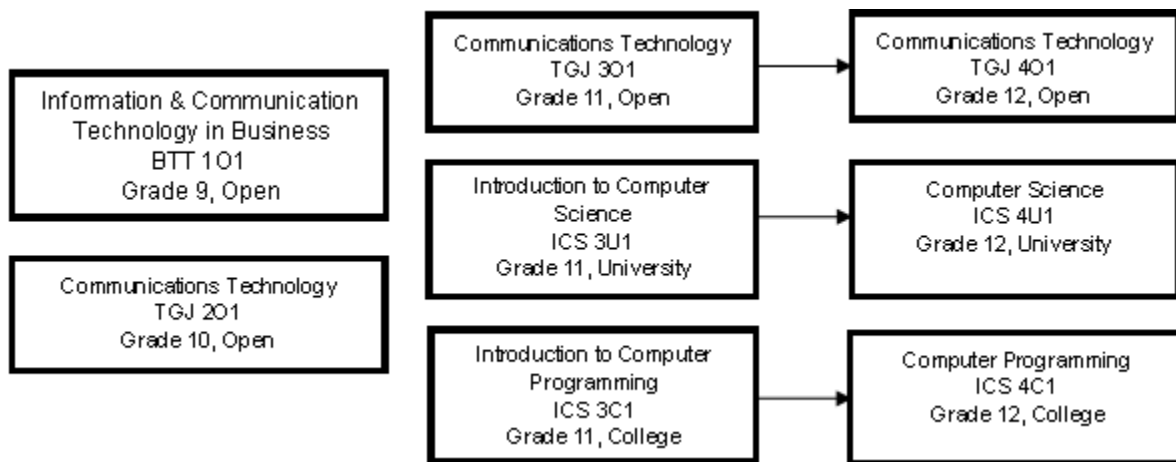

INFORMATION AND COMMUNICATION TECHNOLOGY IN BUSINESS

Grade 9 - Open

BTT101

This course introduces students to information and communication technology in a business environment and builds a foundation of digital literacy skills necessary for success in a technologically driven society. Students will develop word processing, spreadsheet, database, desktop publishing, presentation software, and website design skills. Throughout the course, there is an emphasis on digital literacy, effective electronic research and communication skills, and current issues related to the impact of information and communication technology. At St. Paul BTT101 will focus on providing hands on experience learning the computer software that students may need in order to complete projects required at secondary school and beyond. Programs may include Word, Excel, Powerpoint, Desktop Publisher and others.

Prerequisite: None

COMMUNICATIONS TECHNOLOGY

Grade 10 - Open

TGJ 201

This course introduces students to communications technology from a media perspective. Students will work in the areas of TV/video and movie production, radio and audio production, print and graphic communications, photography, and interactive new media and animation. Student projects may include computer-based activities such as creating videos, editing photos, working with audio, cartooning, developing animations, and designing web pages. Students will also develop an awareness of environmental and societal issues related to communications technology, and will explore secondary and postsecondary education and training pathways and career opportunities in the various communications technology fields. TGJ201 at St. Paul will introduce students to creative applications with project-based modules on web design (Dreamweaver), graphic design (Photoshop, Corel Draw/fireworks, MS Publisher), animation (Flash), video/new media (movie maker/iMovie) and technological design (Computer-Assisted Design).

Prerequisite: None

COMMUNICATIONS TECHNOLOGY – BROADCAST AND PRINT PRODUCTION

Grade 11 - Open

TGJ 301

This course enables students to develop knowledge and skills in the areas of graphic communication, printing and publishing, audio and video production, and broadcast journalism. Students will work both independently and as part of a production team to design and produce media products in a project-driven environment. Practical projects may include the making of signs, yearbooks, video and/or audio productions, newscasts and documentaries. Students will also develop an awareness of related environmental and societal issues, and will explore secondary and postsecondary education and training pathways and career opportunities in the various communications technology fields. At St. Paul students will explore creative uses of communication technologies: web design (Dreamweaver and scripting language), graphic design (Photoshop, Corel Draw/Fireworks, MS Publisher), social media/visual addresses, video and new media (movie maker/iMovie) in project format.

Prerequisite: None

COMMUNICATIONS TECHNOLOGY: DIGITAL IMAGERY AND WEB DESIGN

Grade 12, Open

TGJ 401

This course enables students to develop knowledge and skills in the areas of photography, digital imaging, animation, 3D modelling, and web design. Students will work both independently and as part of a production team to design and produce media products in a project-driven environment. Practical projects may include photo galleries, digital images, animations, 3D models, and websites. Students will also expand their awareness of environmental and societal issues related to communications technology, and will explore postsecondary education, training, and career opportunities. At St. Paul student will further extend their exploration of creative uses of communication technologies: web design (Dreamweaver and scripting languages), graphic design (Photoshop, Corel Draw/Fireworks, MS Publisher), social media/visual addresses, video and new media (movie maker/iMovie) through a project-based curriculum.

Prerequisite: None

INTRODUCTION TO COMPUTER SCIENCE

Grade 11 - University Preparation

ICS 3U1

This course introduces students to computer science. Students will design software independently and as part of a team, using industry-standard programming tools and applying the software development life-cycle mode. They will also write and use subprograms within computer programs. Students will develop creative solutions for various types of problems as their understanding of the computing environment grows. They will also explore environmental and ergonomic issues, emerging research in computer science, and global career trends in computer-related fields.

Prerequisite: None

This course is offered every other year. It will be offered for the 2016-2017 school year.

COMPUTER SCIENCE

Grade 12 - University Preparation

ICS 4U1

This course enables students to further develop knowledge and skills in computer science. Students will use modular design principles to create complex and fully documented programs, according to industry standards. Student teams will manage a large software development project, from planning through to project review. Students will also analyse algorithms for effectiveness. They will investigate ethical issues in computing and further explore environmental issues, emerging technologies, areas of research in computer science, and careers in the field.

Prerequisite: ICS3U1

This course is offered every other year. It will be offered for the 2015-2016 school year.

INTRODUCTION TO COMPUTER PROGRAMMING

Grade 11 - College Preparation

ICS 3C1

This course introduces students to computer programming concepts and practices. Students will write and test computer programs, using various problem-solving strategies. They will learn the fundamentals of program design and apply a software development life-cycle model to a software development project. Students will also learn about computer environments and systems, and explore environmental issues related to computers, safe computing practices, emerging technologies, and postsecondary opportunities in computer-related fields.

Prerequisite: None

This course is offered every other year. It will be offered for the 2016-2017 school year.

COMPUTER PROGRAMMING

Grade 12 - College Preparation

ICS 4C1

This course further develops students' computer programming skills. Students will learn object-oriented programming concepts, create object-oriented software solutions, and design graphical user interfaces. Student teams will plan and carry out a software development project using industry-standard programming tools and proper project management techniques. Students will also investigate ethical issues in computing, and expand their understanding of environmental issues, emerging technologies, and computer-related careers.

Prerequisite: ICS3C1

This course is offered every other year. It will be offered for the 2015-2016 school year.

ALGONQUIN & LAKESHORE TECHNOLOGY CENTRE

Sir James Whitney campus

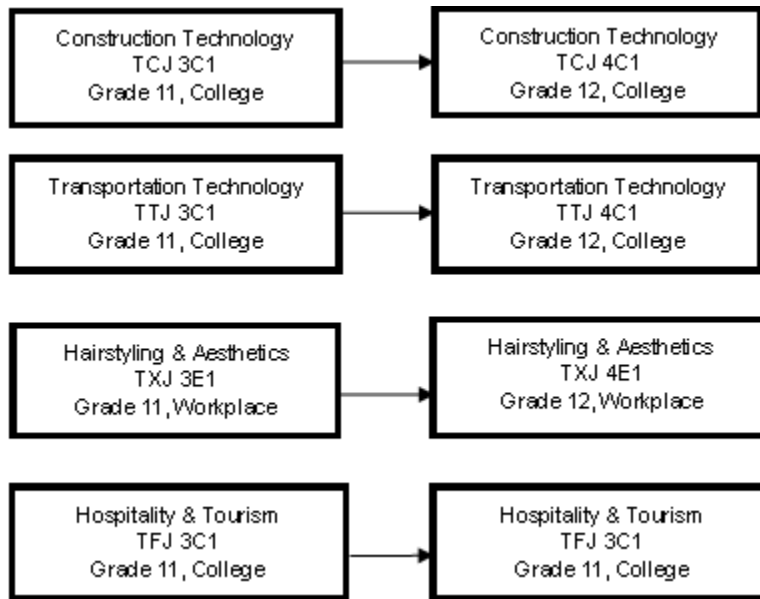

The following courses are available off-campus at the Algonquin Lakeshore Technology Centre located at Sir James Whitney School in Belleville. Transportation to and from St. Paul is provided. These courses are taken as two-credit packages in one semester. Transportation or Hairstyling and Aesthetics or Hospitality & Tourism courses can be taken as part of a Specialist High Skills Major at St. Paul. See page 44 of this calendar or your guidance counselor for more information.

TRANSPORTATION TECHNOLOGY

Grade 11 - College Preparation

TTJ 3C1

This course enables students to develop technical knowledge and skills as they study, test, service, and repair engine, electrical, suspension, brake, and steering systems on vehicles, aircraft, and/or watercraft. Students will develop communication and teamwork skills through practical tasks, using a variety of tools and equipment. Students will develop an awareness of environmental and societal issues related to transportation and will learn about apprenticeship and college programs leading to careers in the transportation industry. This is a two credit program. Prerequisite: None

TRANSPORTATION TECHNOLOGY

Grade 12 - College Preparation

TTJ 4C1

This course enables students to further develop technical knowledge and skills as they study, test, service, and repair engine management systems; powertrains; steering/control, suspension, brake, and body systems on vehicles, aircraft, and/or watercraft; and/or small-engine products. Students will refine communication and teamwork skills through practical tasks, using a variety of tools and equipment. Students will expand their awareness of environmental and societal issues related to transportation and their knowledge of apprenticeship and college programs leading to careers in the transportation industry. This is a 2 credit program.

Prerequisite: TTJ 3C1

CONSTRUCTION ENGINEERING TECHNOLOGY

Grade 11 - College Preparation

TCJ 3C1

This course focuses on the development of knowledge and skills related to residential construction. Students will gain hands on experience using a variety of construction materials, processes, tools, and equipment; learn about building design and planning construction projects; create and interpret working drawings and sections; and learn how the Ontario Building Code and other regulations and standards apply to construction projects. Students will also develop an awareness of environmental and societal issues related to construction technology, and explore career opportunities in the field. This is a two credit course.

Prerequisite: None

CONSTRUCTION ENGINEERING TECHNOLOGY

Grade 12 - College Preparation

TCJ4C1

This course enables students to further develop technical knowledge and skills related to residential construction and to explore light commercial construction. Students will gain hands on experience using a variety of materials, processes, tools, and equipment and will learn more about building design and project planning. They will continue to create and interpret construction drawings and will extend their knowledge of construction terminology and of relevant building codes and regulations, as well as health and safety standards and practices. Students will also focus on environmental and societal issues related to construction engineering technology, and explore career opportunities in the field. This is a 2 credit program.

Prerequisite: TCJ 3C1

HAIRSTYLING AND AESTHETICS

Grade 11 - Workplace Preparation

TXJ 3E1

This course enables students to develop knowledge and skills in cosmetology and offers a variety of applications that will equip students to provide services for a diverse clientele. Students will identify trends in the hairstyling and aesthetics industry, learn about related health and safety laws, and expand their communication and interpersonal skills through interactions with peers and clients. Student will also consider environmental and societal issues related to the industry and will acquire a more detailed knowledge of apprenticeships and direct-entry work positions. This is a 2 credit program.

Prerequisite: None

HAIRSTYLING AND AESTHETICS

Grade 12 - Workplace Preparation

TXJ 4E1

This course enables students to develop increased proficiency in a wide range of hairstyling and aesthetics services. Working in a salon/spa team environment, students will strengthen their fundamental cosmetology skills and develop and understanding of common business practices and strategies in the salon/spa industry. Students will also expand their understanding of environmental and societal issues and their knowledge of postsecondary destinations in the hairstyling and aesthetics industry. This is a 2 credit program.

Prerequisite: TXJ 3E1

HOSPITALITY AND TOURISM

Grade 11 - College Preparation

TFJ 3C1

This course enables students to develop or expand knowledge and skills related to hospitality and tourism, as reflected in the various sectors of the tourism industry. Students will learn about preparing and presenting food, evaluating facilities, controlling inventory, and marketing and managing events and activities, and will investigate customer service principles and the cultural and economic forces that drive tourism trends. Students will develop an awareness of health and safety standards, environmental and societal issues, and career opportunities in the tourism industry.

Prerequisite: None

HOSPITALITY AND TOURISM
Grade 12 - College Preparation
TFJ 4C1

This course enables students to further develop knowledge and skills related to the various sectors of the tourism industry. Students will demonstrate advanced food preparation and presentation skills; increase health and wellness knowledge; develop tourism administration and management skills; design and implement a variety of events or activities; and investigate principles and procedures that contribute to high-quality customer service. Students will expand their awareness of health and safety issues, environmental and societal issues, and career opportunities in the tourism industry.

Prerequisite: TFJ3C1

ST. PAUL COURSE OFFERINGS 2016 – 2017

Areas of Study	Course Name	Grade 10	Grade 11	Grade 12
RELIGIOUS STUDIES	Religious Education	HRE2O1		
	World Religions & Belief Traditions		HRT3M1* HRT3O1*	
	Church and Culture			HRE4M1 HRE4O1
THE ARTS	Drama	ADA2O1	ADA3M1	ADA4M1
	Visual Arts	AVI2O1	AVI3M1	AVI4M1
	Digital Art Photography		AWQ3M1	
	Music	AMU2O1	AMU3M1	AMU4M1
	Media Arts		ASM3O1*	ASM4E1
BUSINESS STUDIES	Introduction to Business	BBI2O1		
	Marketing: Goods, Services, Events		BMI3C1*	
	Financial Accounting Fundamentals		BAF3M1	
	Financial Accounting Principals			BAT4M1 (2017/18)
CANADIAN & WORLD STUDIES	Civics and Citizenship	CHV2O5		
	Canadian History	CHC2D1 CHC2P1		
	Travel & Tourism		CGG3O1*	
	Forces of Nature		CGF3M1	
	World History		CHW3M1 (2016/17)*	
	American History		CHA3U1 (2017/18)*	
	Understanding Canadian Law		CLU3M1*	
	World Issues: a Geographic Analysis			CGW4U1*
	Canada: History, Identity & Culture			CHI4U1 (2016/17)*
	World History since the 15 Century			CHY4U1 (2017/18)*
	Analysing Current Economic Issues			CIA4U1
	Canadian & International Law			CLN4U1*
	Canada & World Politics			CPW4U1*

Denotes courses which can be completed as part of the 4 Major credits for the Non-Profit SHSM

Areas of Study	Course Name	Grade 10	Grade 11	Grade 12
----------------	-------------	----------	----------	----------

ENGLISH	English (compulsory)	ENG2D1 ENG2P1 ENG2L1	ENG3U1 ENG3C1 ENG3E1	ENG4U1 ENG4C1 ENG4E1
	Media Studies		EMS3O1*	
	Communications in Business & Technology			EBT4O1
	Writer's Craft			EWC4U1
	Ontario Secondary School Literacy Course			OLC4O1
FRENCH	Core French	FSF2D1 FSF2P1	FSF3U1	FSF4U
	Extended French	FEF2D1	FEF3U1	FEF4U
	Histoire du Canada	CHC2DF(2016/17)		
	Religion du Monde		HRT3MF(2017/18)	
GUIDANCE & CAREER EDUCATION	Career Studies	GLC2O5		
	Leadership & Peer Support		GPP3O1	
	Co-operative Education		Co-op	Co-op
	Peer Mediation			IDC4U1* IDC4O1*
HEALTHY & PHYSICAL EDUCATION	Healthy Active Living	PPL2O1	PPL3O1	PPL4O1
	Large Group Activities-Hockey	PAL2O1		PAL4O1
	Personal & Fitness Activities		PAF3O1	PAF4O1
	Kinesiology			PSK4U1
HUMANITIES & SOCIAL SCIENCE	Living & Working with Children		HPW3C1	
	Introduction to Anthropology, Psychology & Sociology		HSP3U1* HSP3C1*	
	Families in Canada			HHS4U1* HHS4C1*

*Denotes courses which can be completed as part of the 4 Major credits for the Non-Profit SHSM

ST. PAUL COURSE OFFERINGS 2016 - 2017

*Denotes courses which can be completed as part of the 4 Major credits for the Non-Profit SHSM

Area of Study	Course Name	Grade 10	Gr. 11	Gr. 12
MATHEMATICS	Principals of Mathematics	MPM2D1		
	Foundations of Mathematics	MFM2P1		
	Essentials of Mathematics	MAT2L1		
	Functions		MCR3U1	
	Functions & Applications		MCF3M1	
	Foundations of College Math		MBF3C1	
	Mathematics for Work & Everyday Life		MEL3E1	MEL4E1
	Advanced Functions			MHF4U1
	Calculus & Vectors			MCV4U1
	Mathematics of Data Management			MDM4U1
	Mathematics of College Technology			MCT4C1
College & Apprenticeship Mathematics			MAP4C1	
SCIENCE	Science	SNC2D1 SNC2P1 SNC2L1		
	Environmental Science		SVN3E1*	
	Biology		SBI3U1 SBI3C1	SBI4U1
	Chemistry		SCH3U1	SCH4U1 SCH4C1
	Physics		SPH3U1	SPH4U1 SPH4C1
TECHNOLOGY	Communication Technology	TGJ2O1	TGJ3O1*	TGJ4O1*
	Computer Science		ICS3U1	ICS4U1
	Computer Programming		ICS3C1	ICS4C1
	Construction Technology at Sir James Whitney		TCJ3C1	TCJ4C1
	Hospitality & Tourism at Sir James Whitney		TFJ3C1	TFJ4C1
	Transportation Technology at Sir James Whitney		TTJ3C1	TTJ4C1
	Hairstyling & Aesthetics at Sir James Whitney		TXJ3E1	TXJ4E1